

描述 / Descriptions

SOT-23 塑封封装 NPN 半导体三极管。Silicon NPN transistor in a SOT-23 Plastic Package.

特征 / Features

高 h_{FE} , 高 V_{CEO} , 与 2SA812 互补。

High h_{FE} and V_{CEO} , complementary pair with 2SA812.

用途 / Applications

用于一般音频放大。

Audio frequency general amplifier application.

内部等效电路 / Equivalent Circuit

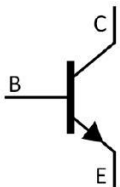

引脚排列 / Pinning



PIN1 : Base PIN 2 : Emitter PIN 3 : Collector

放大及印章代码 / h_{FE} Classifications & Marking

h_{FE} Classifications Symbol	O	Y	G	L
h_{FE} Range	90~180	135~270	200~400	300~600
Marking	HL4	HL5	HL6	HL7

极限参数 / Absolute Maximum Ratings(Ta=25°C)

参数 Parameter	符号 Symbol	数值 Rating	单位 Unit
Collector to Base Voltage	V_{CBO}	60	V
Collector to Emitter Voltage	V_{CEO}	50	V
Emitter to Base Voltage	V_{EBO}	5.0	V
Collector Current	I_C	100	mA
Collector Power Dissipation	P_C	200	mW
Junction Temperature	T_j	150	°C
Storage Temperature Range	T_{stg}	-55~150	°C

电性能参数 / Electrical Characteristics(Ta=25°C)

参数 Parameter	符号 Symbol	测试条件 Test Conditions	最小值 Min	典型值 Typ	最大值 Max	单位 Unit
Collector Cut-Off Current	I_{CBO}	$V_{CB}=60V$ $I_E=0$			0.1	μA
Emitter Base Cut-Off Current	I_{EBO}	$V_{EB}=5.0V$ $I_C=0$			0.1	μA
DC Current Gain	h_{FE}	$V_{CE}=6.0V$ $I_C=1.0mA$	90	200	600	
Collector to Emitter Saturation Voltage	$V_{CE(sat)}$	$I_C=100mA$ $I_B=10mA$		0.15	0.3	V
Base to Saturation Voltage	$V_{BE(sat)}$	$I_C=100mA$ $I_B=10mA$		0.86	1.0	V
Base Emitter Voltage	V_{BE}	$V_{CE}=6.0V$ $I_C=1.0mA$	0.55	0.62	0.65	V
Transition Frequency	f_T	$V_{CE}=6.0V$ $I_E=10mA$		250		MHz
Collector Output Capacitance	C_{ob}	$V_{CB}=6.0V$ $I_E=0$ $f=1.0MHz$		3.0		pF

电参数曲线图 / Electrical Characteristic Curve

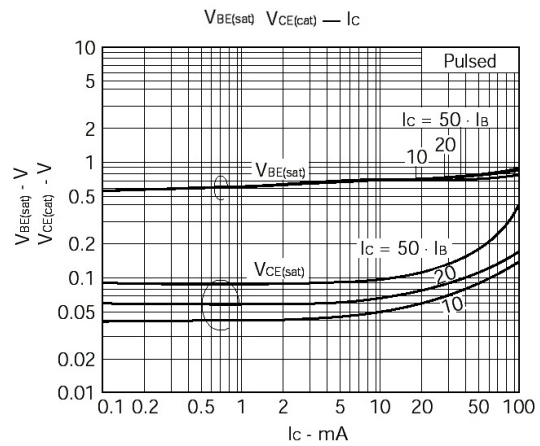
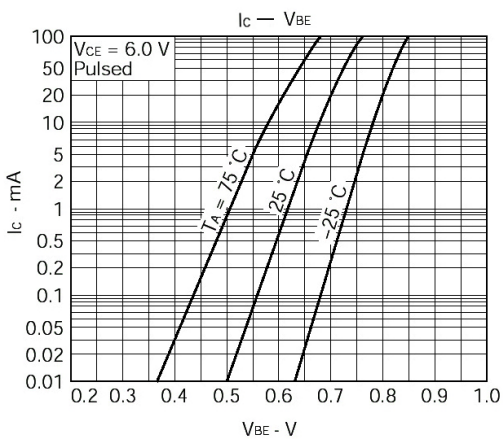
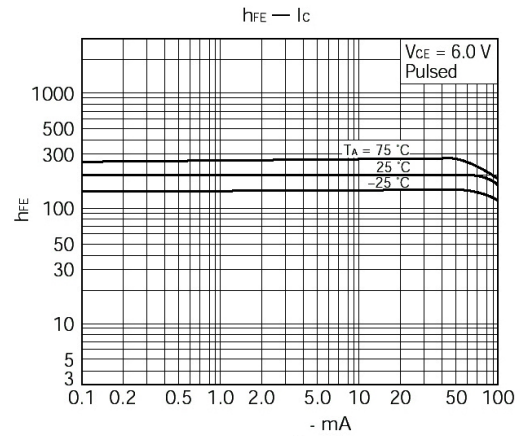
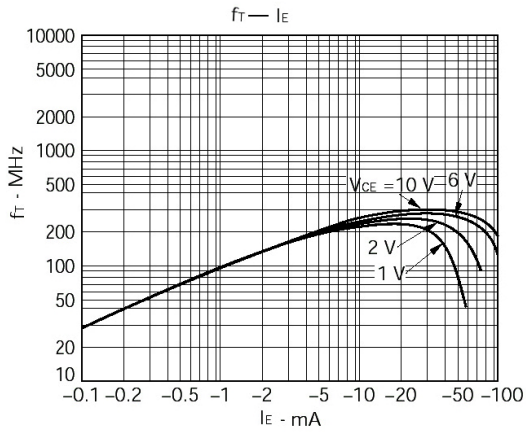
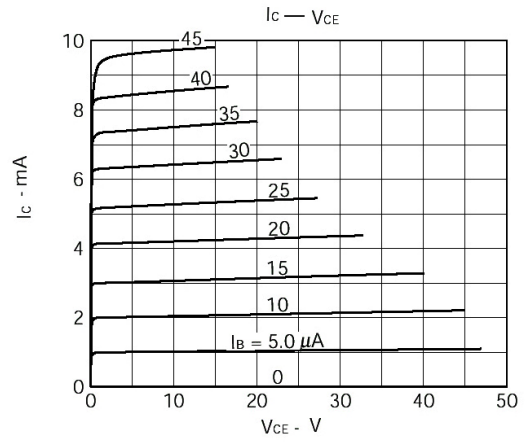
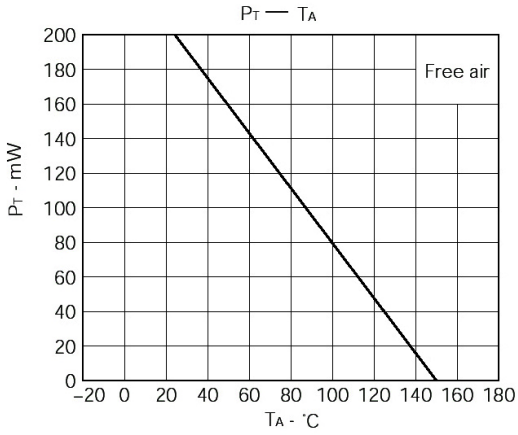

外形尺寸图 / Package Dimensions

SOT-23

单位: mm

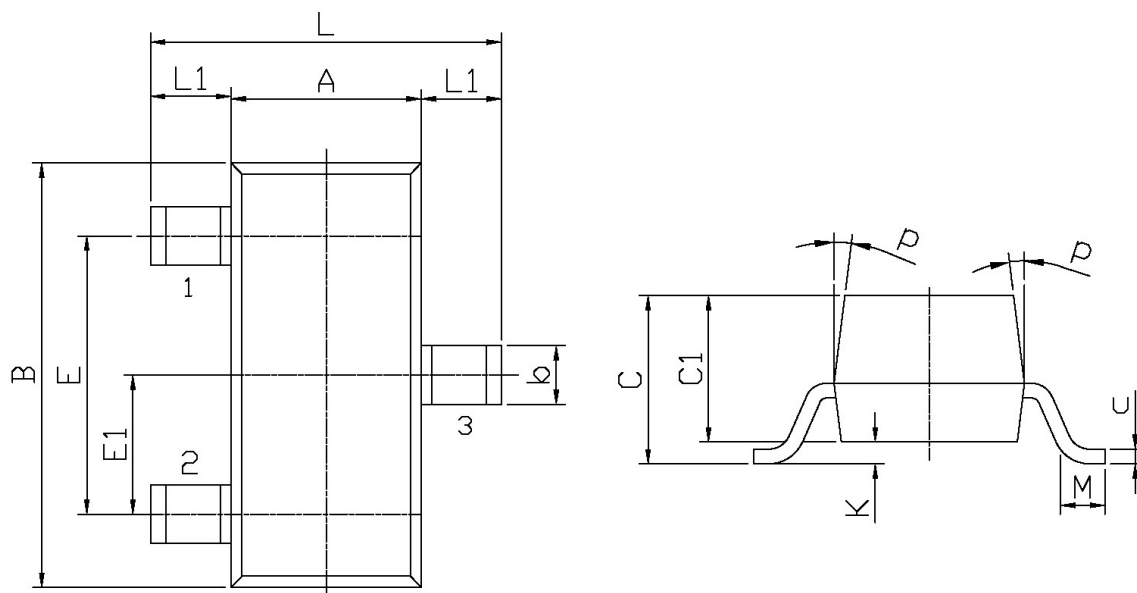

Symbol	Dimensions In Millimeters		Symbol	Dimensions In Millimeters	
	Min	Max		Min	Max
L	2.2	2.7	C	1.30Max	
L1	0.45	0.65	C1	0.90	1.20
A	1.15	1.50	c	0.05	0.20
B	2.70	3.10	K	0	0.10
E	1.70	2.10	M	0.20MIN	
E1	0.85	1.05	P	7°	
b	0.35	0.55			

印章说明 / Marking Instructions

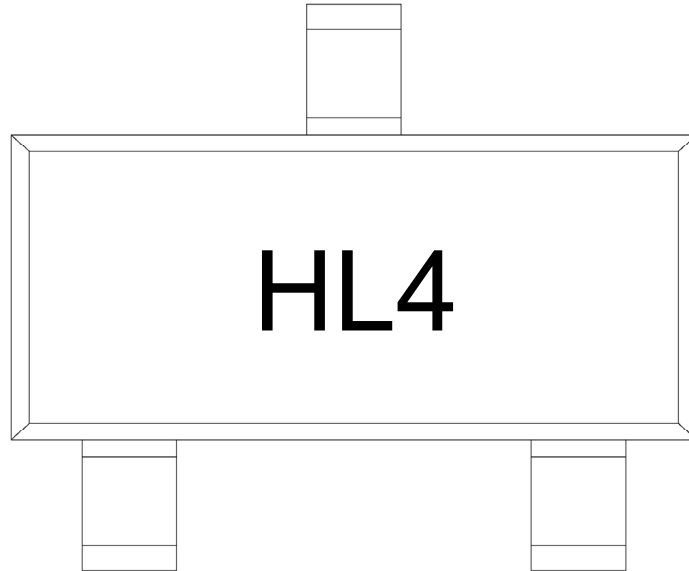

说明：

H： 为公司代码

L4： 为型号代码

Note:

H: Company Code.

L4: Product Type Code

回流焊温度曲线图(无铅) / Temperature Profile for IR Reflow Soldering(Pb-Free)



说明：

- 1、预热温度 25~150°C，时间 60~90sec;
- 2、峰值温度 245±5°C，时间持续为 5±0.5sec;
- 3、焊接制程冷却速度为 2~10°C/sec.

Note:

- 1.Preheating:25~150°C, Time:60~90sec.
- 2.Peak Temp.:245±5°C, Duration:5±0.5sec.
3. Cooling Speed: 2~10°C/sec.

耐焊接热试验条件 / Resistance to Soldering Heat Test Conditions

温度：260±5°C

时间：10±1 sec.

Temp.:260±5°C

Time:10±1 sec

包装规格 / Packaging SPEC.

卷盘包装 / REEL

Package Type 封装形式	Units 包装数量					Dimension 包装尺寸 (unit: mm ³)		
	Units/Reel 只/卷盘	Reels/Inner Box 卷盘/盒	Units/Inner Box 只/盒	Inner Boxes/Outer Box 盒/箱	Units/Outer Box 只/箱	Reel	Inner Box 盒	Outer Box 箱
SOT-23	3,000	10	30,000	6	180,000	7" x8	180×120×180	390×385×205

使用说明 / Notices