

**描述 / Descriptions**

TO-220 塑封封装电压调整器。Voltage Regulator in a TO-220 Plastic Package.

**特征 / Features**

三端稳压调整器，输出电流高达 1.5A,内设过热保护和短路限制。

3-Terminal regulators ,output current up to 1.5 A, internal thermal overload protection and short-circuit limiting.

**用途 / Applications**

电压调整器。

Voltage Regulator.

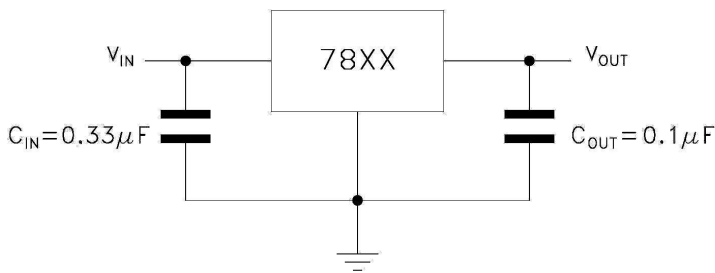
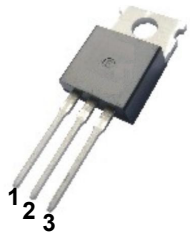
**内部等效电路/应用电路 / Equivalent Circuit or Application Circuit****引脚排列 / Pinning**

PIN 1 : IN

PIN 2 : GND

PIN 3 : OUT

**印章代码 / Marking**

见印章说明。See Marking Instructions

**极限参数 / Absolute Maximum Ratings(Ta=25°C)**

参数 Parameter	符号 Symbol	数值 Rating	单位 Unit
Input Voltage Difference	$V_i$	35	V
Junction-to-Ambient	$R_{\theta JA}$	50	°C/W
Junction-to-Case	$R_{\theta JC}$	5.0	°C/W
Operating Temperature Range	$T_{OPR}$	0~125	°C
Storage temperature range	$T_{stg}$	-65~150	°C

**电性能参数 / Electrical Characteristics(Ta=25°C ,  $V_i=23V, I_o=500mA$  , unless otherwise specified)**

参数 Parameter	符号 Symbol	测试条件 Test Conditions	最小值 Min	典型值 Typ	最大值 Max	单位 Unit
Output Voltage	$V_o$	$T_j=25^\circ\text{C}$	14.4	15	15.6	V
		$V_i=17.5V-30V$ $I_o=5.0mA-1.0A$ $P_o \leq 15W$	14.25	15	15.75	
Load Regulation	$\Delta V_{Load}$	$T_j=25^\circ\text{C}$ $I_o=5.0mA-1.5A$			300	mV
		$T_j=25^\circ\text{C}$ $I_o=250mA-750mA$			150	
Line Regulation	$\Delta V_{Line}$	$T_j=25^\circ\text{C}$ $V_i=17.5V-30V$			300	mV
		$T_j=25^\circ\text{C}$ $V_i=20V-26V$			150	
Quiescent Current	$I_q$	$T_j=25^\circ\text{C}$			8.0	mA
Quiescent Current Change	$\Delta I_q$	$V_i=17.5V-30V$			1.0	mA
		$I_o=5.0mA-1.0A$			0.5	mA
Output Voltage Drift	$\Delta V_o/\Delta T$	$I_o=5.0mA$		-1.0		mV/°C
Output Noise Voltage	eN	B=10Hz-100KHz $T_j=25^\circ\text{C}$		90		$\mu V/V_o$
Supply Voltage Rejection	SVR	$V_i=18.5V-28.5V$ $f=120Hz$	54			dB
Dropout Voltage	$V_d$	$I_o=1A$ $T_j=25^\circ\text{C}$		2.0		V
Output Resistance	$R_o$	$f=1.0KHz$		19		m $\Omega$
Short Circuit Current	$I_{sc}$	$V_i=35V$ $T_j=25^\circ\text{C}$		0.23		A
Short Circuit Peak Current	$I_{scp}$	$T_j=25^\circ\text{C}$		2.2		A

电参数曲线图 / Electrical Characteristic Curve

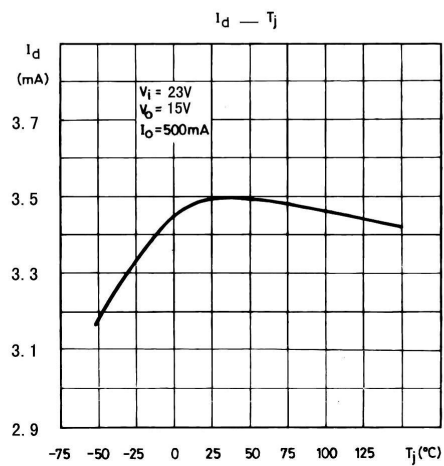
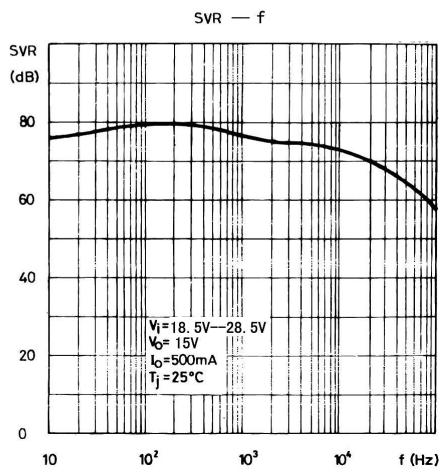
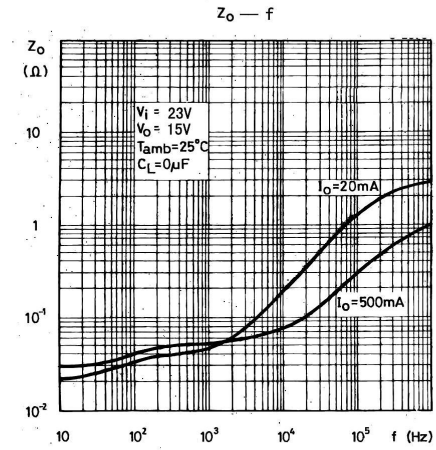
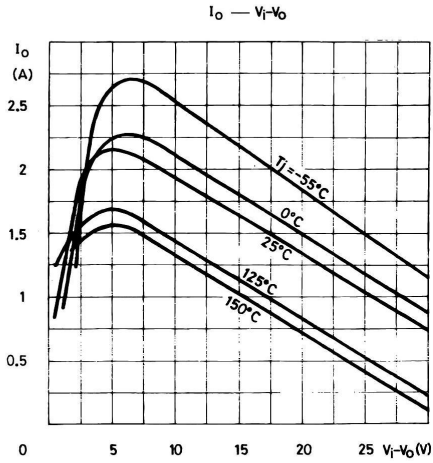
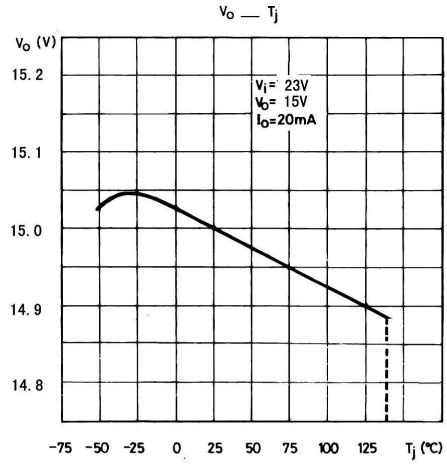
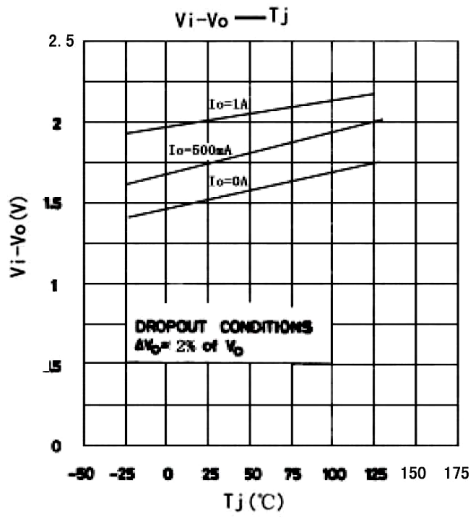

外形尺寸图 / Package Dimensions

TO-220

单位: mm

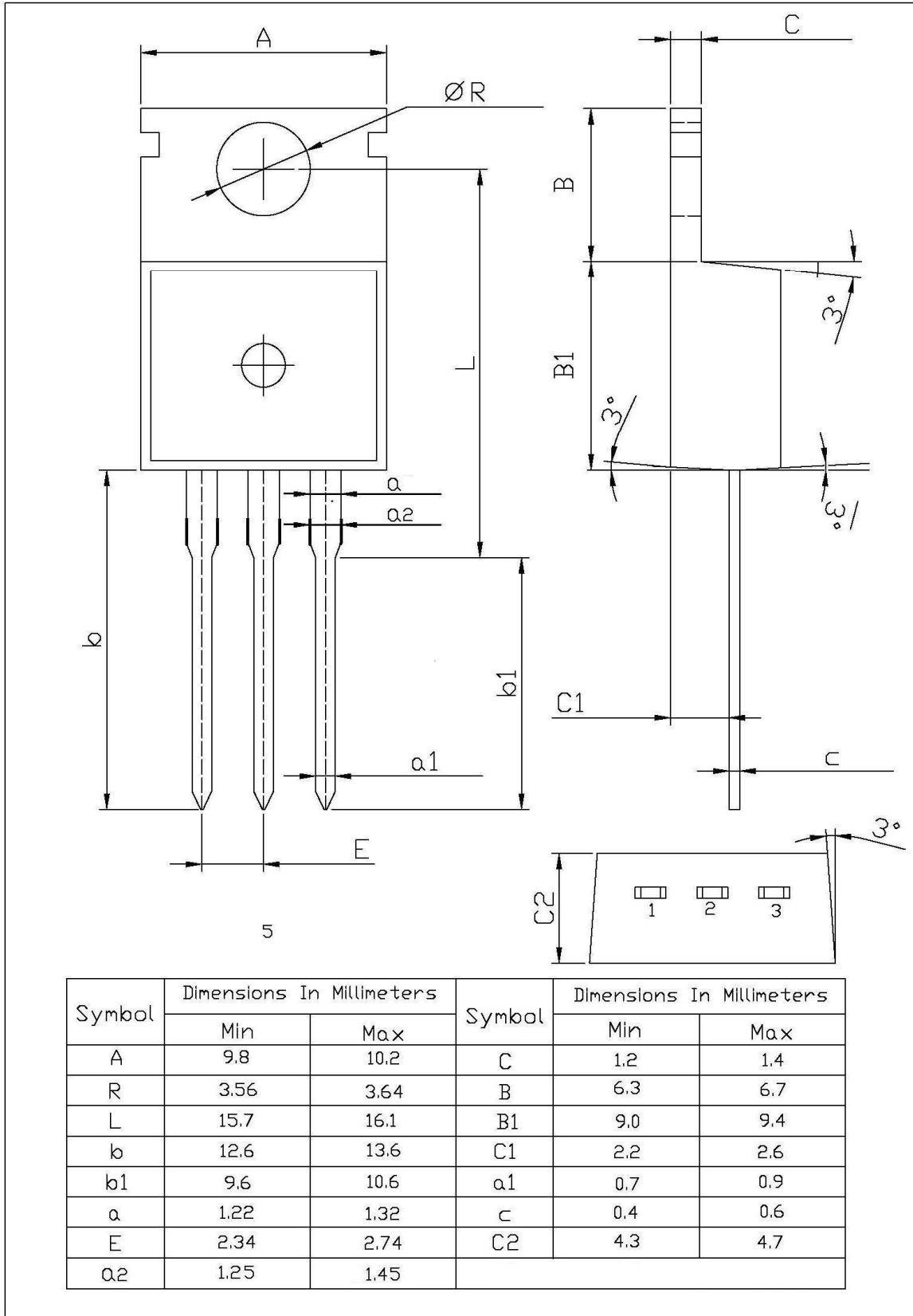

## 印章说明 / Marking Instructions

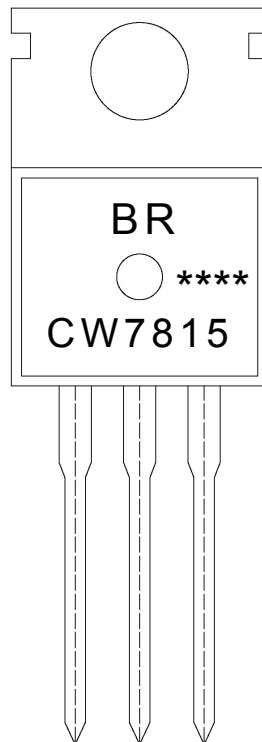

说明：

BR： 为公司代码

CW7815： 为产品型号

\*\*\*\*： 为生产批号代码，随生产批号变化。

Note:

BR: Company Code.

CW7815: Product Type.

\*\*\*\*: Lot No. Code, code change with Lot No.

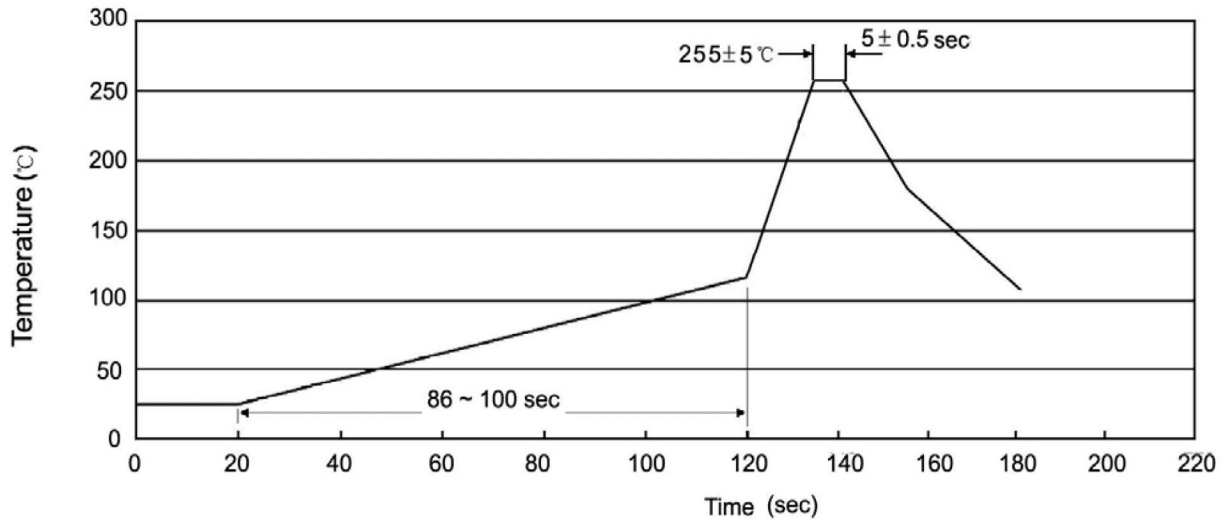
**波峰焊温度曲线图(无铅) / Temperature Profile for Dip Soldering(Pb-Free)**

说明：

- 1、预热温度 25 ~ 150°C，时间 60 ~ 90sec;
- 2、峰值温度 255±5°C，时间持续为 5±0.5sec;
- 3、焊接制程冷却速度为 2 ~ 10°C/sec.

Note:

- 1.Preheating:25~150°C, Time:60~90sec.
- 2.Peak Temp.:255±5°C, Duration:5±0.5sec.
3. Cooling Speed: 2~10°C/sec.

**耐焊接热试验条件 / Resistance to Soldering Heat Test Conditions**

温度：270±5°C

时间：10±1 sec.

Temp:270±5°C

Time:10±1 sec

**包装规格 / Packaging SPEC.**

散件包装 / BULK

Package Type 封装形式	Units 包装数量					Dimension 包装尺寸 (unit: mm3)		
	Units/Bag 只/袋	Bags/Inner Box 袋/盒	Units/Inner Box 只/盒	Inner Boxes/Outer Box 盒/箱	Units/Outer Box 只/箱	Bag 袋	Inner Box 盒	Outer Box 箱
TO-220/F	200	10	2,000	5	10,000	135×190	237×172×102	560×245×195

套管包装 / TUBE

Package Type 封装形式	Units 包装数量					Dimension 包装尺寸 (unit: mm3)		
	Units/Tube 只/套管	Tubes/Inner Box 套管/盒	Units/Inner Box 只/盒	Inner Boxes/Outer Box 盒/箱	Units/Outer Box 只/箱	Tube 套管	Inner Box 盒	Outer Box 箱
TO-220/F	50	20	1,000	5	5,000	532×31.4×5.5	555×164×50	575×290×180

**使用说明 / Notices**