

描述 / Descriptions

TO-252 塑封封装电压调整器。Voltage Regulator in a TO-252 Plastic Package.

特征 / Features

三端稳压调整器，输出电流高达 1.0A,内设过热保护和短路限制，无卤产品。

3-Terminal regulators ,output current up to 1.0A, internal thermal overload protection and short-circuit limiting, HF Product.

用途 / Applications

电压调整器。

Voltage Regulator.

内部等效电路/应用电路 / Equivalent Circuit or Application Circuit

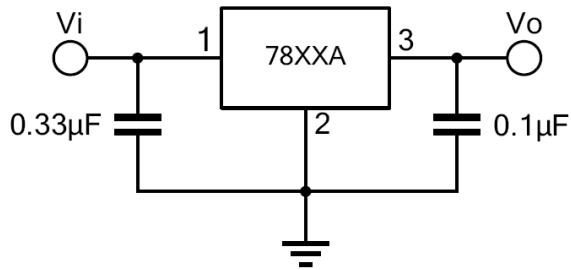

引脚排列 / Pinning

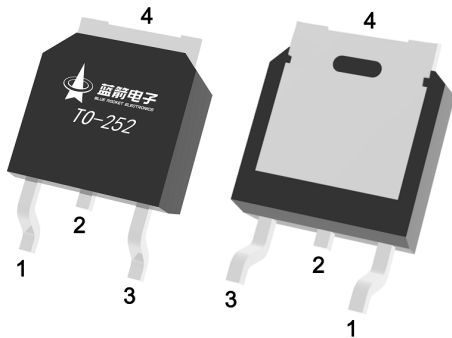

PIN1 : IN

PIN 2、 4 : GND

PIN 3 : OUT

印章代码 / Marking

见印章说明。

See Marking Instructions.

极限参数 / Absolute Maximum Ratings(Ta=25°C)

参数 Parameter	符号 Symbol	数值 Rating	单位 Unit
Input voltage	V _I	7~35	V
Power Dissipation	P _D	Internally Limited	W
Thermal Resistance Junction-ambient	R _{θJA}	105	°C/W
Thermal Resistance Junction-case	R _{θJC}	10	°C/W
Operating Temperature Range	T _{OPR}	-40~125	°C
Storage temperature range	T _{stg}	-65~150	°C

电性能参数 / Electrical Characteristics(V_i=19V,I_o=500mA,T_j=-30°C~125°C,unless otherwise specified)

参数 Parameter	符号 Symbol	测试条件 Test Conditions	最小值 Min	典型值 Typ	最大值 Max	单位 Unit
Output Voltage	V _o	T _j =25°C	11.5	12.0	12.5	V
		V _i =14.5V~27V I _o =5mA~1.0A P _D ≤15W	11.4	12.0	12.6	V
Load Regulation	ΔV _{Load}	T _j =25°C I _o =5mA~1.0A			240	mV
		T _j =25°C I _o =250mA~750mA			120	mV
Line Regulation	ΔV _{Line}	T _j =25°C V _i =14.5V~30V			240	mV
		T _j =25°C V _i =16V~22V			120	mV
Quiescent Current	I _q	T _j =25°C			8.0	mA
Quiescent Current Change	ΔI _q	V _i =14.5V~30V			1.0	mA
		I _o =5mA~1.0A			0.5	mA
Output Voltage Drift	ΔV _o /ΔT	I _o =5mA T _j =0~125°C		-1.0		mV/°C
Output Noise Voltage	e _N	B=10Hz~100KHz T _j =25°C		75		μV/V _o
Supply Voltage Rejection	SVR	V _i =15V~25V f=120Hz	55			dB
Dropout Voltage	V _d	I _o =1.0A T _j =25°C		2.0		V
Output Resistance	R _o	f=1KHz		18		mΩ
Short Circuit Current	I _{sc}	V _i =35V T _j =25°C		200		mA

电参数曲线图 / Electrical Characteristic Curve

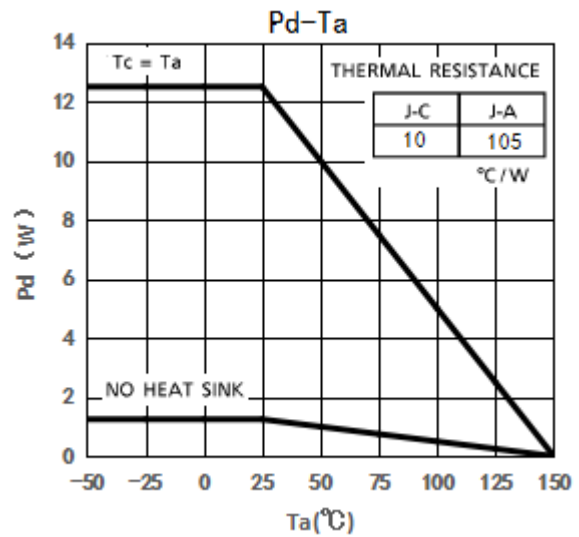
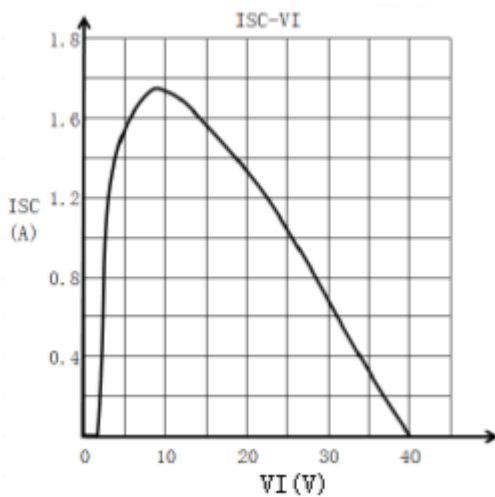
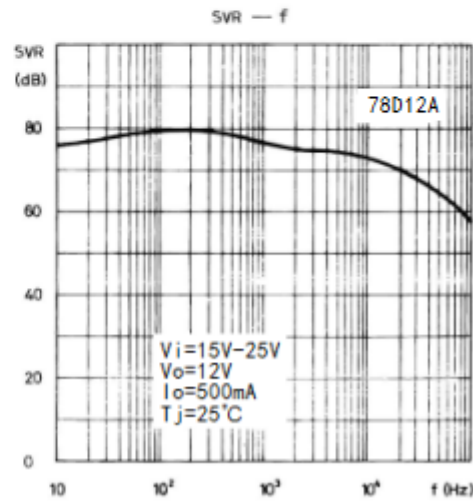
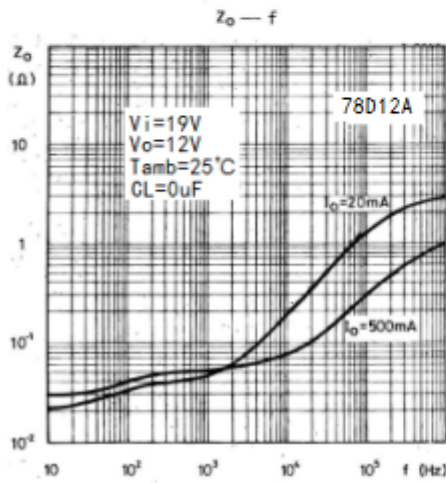
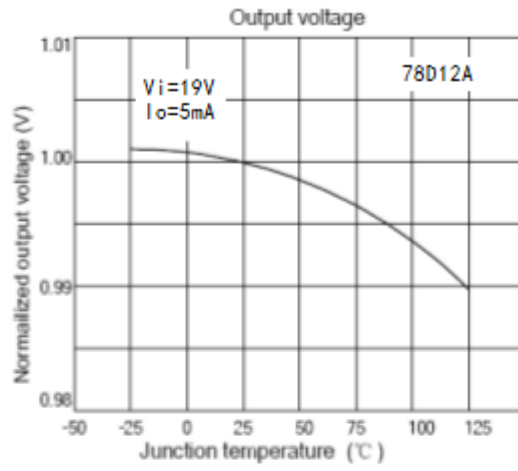
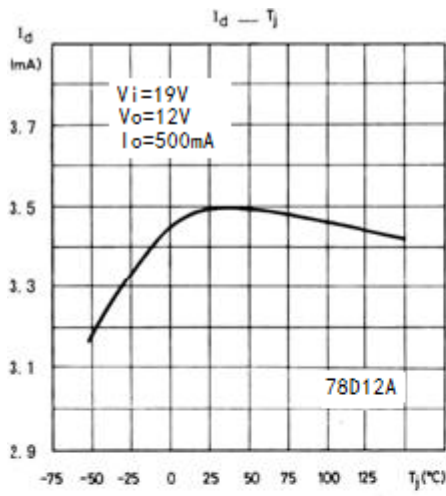

外形尺寸图 / Package Dimensions

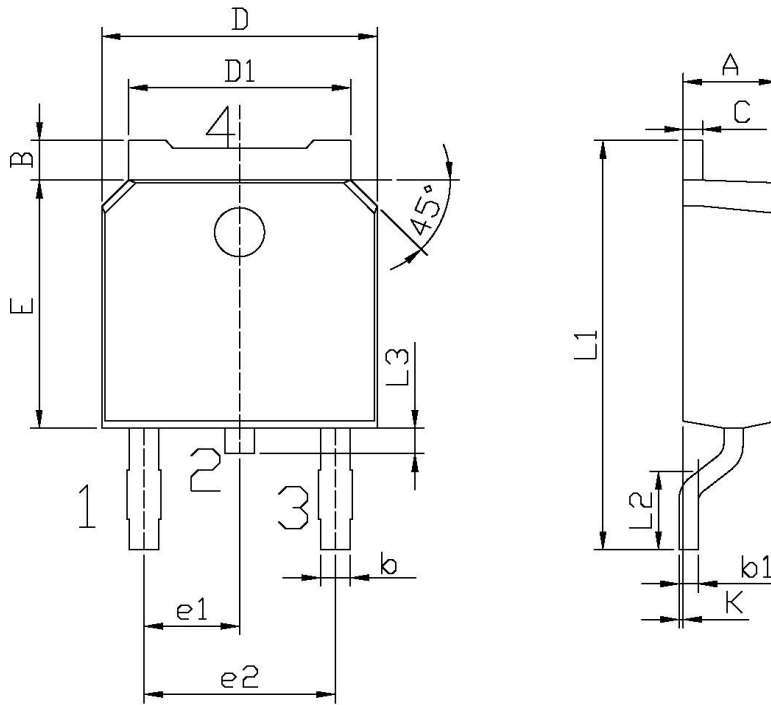

单位: mm

Symbol	Dimensions In Millimeters		Symbol	Dimensions In Millimeters	
	Min	Max		Min	Max
A	2.20	2.40	E	5.95	6.25
B	0.95	1.25	e1	2.24	2.34
b	0.70	0.90	e2	4.43	4.73
b1	0.45	0.55	L1	9.85	10.35
C	0.45	0.55	L2	1.70	2.00
D	6.45	6.75	L3	0.60	0.90
D1	5.10	5.50	K	0.00	0.10

TO-252

印章说明 / Marking Instructions

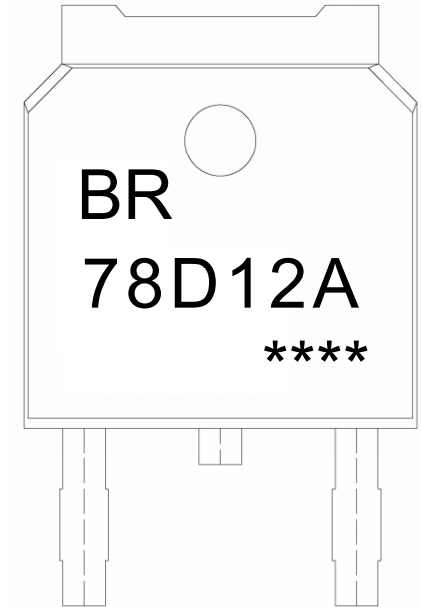

说明：

BR： 为公司代码

78D12A： 为产品型号

****： 为生产批号代码，随生产批号变化

Note:

BR: Company Code

78D12A: Product Type

****: Lot No. Code, code change with Lot No

回流焊温度曲线图(无铅) / Temperature Profile for IR Reflow Soldering(Pb-Free)

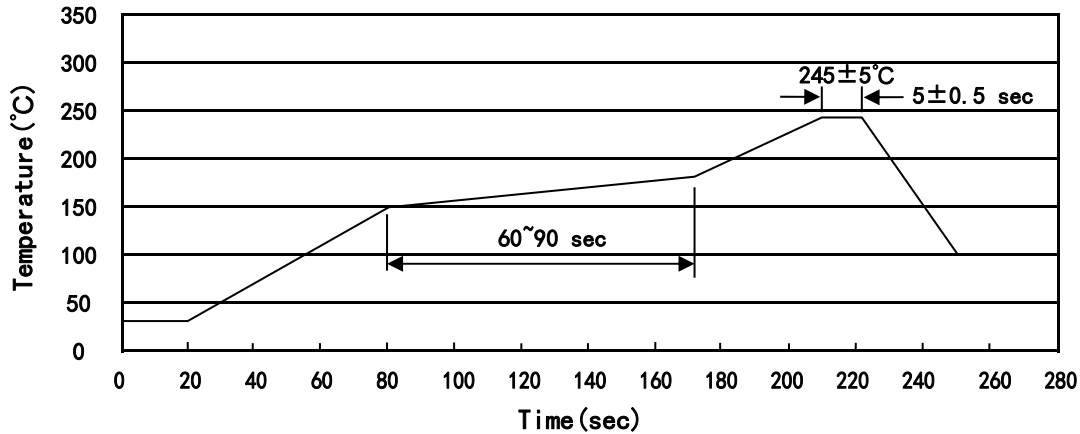

说明：

- 1、预热温度 150~180°C，时间 60~90sec;
- 2、峰值温度 245±5°C，时间持续为 5±0.5sec;
- 3、焊接制程冷却速度为 2~10°C/sec.

Note:

- 1.Preheating:150~180°C, Time:60~90sec.
- 2.Peak Temp.:245±5°C, Duration:5±0.5sec.
3. Cooling Speed: 2~10°C/sec.

耐焊接热试验条件 / Resistance to Soldering Heat Test Conditions

温度：260±5°C 时间：10±1 sec. Temp.:260±5°C Time:10±1 sec

包装规格 / Packaging SPEC.

卷盘包装 / REEL

Package Type 封装形式	Units 包装数量					Dimension 包装尺寸 (unit: mm ³)		
	Units/Reel 只/卷盘	Reels/Inner Box 卷盘/盒	Units/Inner Box 只/盒	Inner Boxes/Outer Box 盒/箱	Units/Outer Box 只/箱	Reel	Inner Box 盒	Outer Box 箱
TO-252	2,500	2	5,000	6	30,000	13" ×16	360×360×50	380×335×366

套管包装 / TUBE

Package Type 封装形式	Units 包装数量					Dimension 包装尺寸 (unit: mm ³)		
	Units/Tube 只/套管	Tubes/Inner Box 套管/盒	Units/Inner Box 只/盒	Inner Boxes/Outer Box 盒/箱	Units/Outer Box 只/箱	Tube 套管	Inner Box 盒	Outer Box 箱
TO-251/252	75	48	3,600	5	18,000	526×20.5×5.25	555×164×50	575×290×180

使用说明 / Notices

- ◆ 电路输入端和输出端推荐都要放置低频滤波电容和高频滤波电容，低频滤波电容推荐使用电解电容，高频滤波电容推荐使用瓷片电容，且输出端电解电容容量建议要低于输入端电解电容容量，防止掉电时输出电压反串到输入端。PCB 布局时，应将滤波电容分别尽可能靠近电路的输入和输出引脚放置。
- ◆ 输入端和输出端压差不能太大，太大则转换效率急速降低、功耗大，而且当电源变化较大超出极限电压时可能会击穿损坏电路。输入端和输出端压差也不能太小，低于最小压差时会影响输出的稳定性。实际使用时，还需综合考虑输出电流设计值、热阻和封装功耗，选择合适的输入、输出压差，保证整机系统的散热情况，防止整机正常工作温度范围内进入热保护状态。
- ◆ 当整机系统对可靠性要求较高或整机正常工作时供电环境比较恶劣，整机系统设计时，应充分考虑电路的保护措施（如：增加浪涌、过压和过流保护），有效抑制异常高压脉冲或电网浪涌对电路端口的冲击，防止电路异常烧毁失效。