

描述 / Descriptions

BRCM24C04SC 是 SOP-8 封装的容量为 4 Kbit，兼容 I²C 的位串行电擦除只读存储器。无卤产品。
The BRCM24C04SC is 4Kbit I²C-compatible Serial EEPROM (Electrically Erasable Programmable Read-Only Memory) device in a SOP-8 Plastic Package. HF Product Code.

特征 / Features

单电源供电；
最小工作电压低至 1.7V，工作电压在 2.5~5.5V 间，最大时钟频率 1Mhz，工作电压在 1.7~2.5V 间，最大时钟频率 400Khz；
低功耗 CMOS 技术，读操作电流 400uA（最大值），写操作电流 1.6mA（最大值）；
施密特触发，滤波输入以抑制噪声；
顺序和随机读取特征；
16 字节页写入模式；
全存储阵列的写保护；
附加写锁定页和 128 位序列号；
自定时写入周期（最大 5ms）；
高可靠性：读写次数大于 100 万次，数据保存大于 100 年，ESD（HBM 模式）能力：6KV，抗门锁能力：+/-200mA；
Single Supply Voltage;
Minimum operating voltage down to 1.7V, 1 MHz clock from 2.5V to 5.5V, 400kHz clock from 1.7V to 2.5V;
Low power CMOS technology, Read current 400uA, maximum, Write current 1.6mA, maximum;
Schmitt Trigger, Filtered Inputs for Noise Suppression;
Sequential & Random Read Features;
16-byte Page Write Modes;
Write protect of the whole memory array;
Additional Write Lockable Page and 128-bit Serial Number;
Self-timed Write Cycle (5ms maximum);
High Reliability: Endurance: > 1 Million Write Cycles, Data Retention: > 100 Years, HBM: 6KV, Latch up Capability: +/-200mA;

用途 / Applications

家用电器，网络通信，便捷式蓝牙设备，机顶盒，智能电表，指纹解锁装置
Household appliances, Network communications, Portable Bluetooth devices, Set-top boxes, Smart meters, Fingerprint unlocking devices

引脚排列 / Pinning

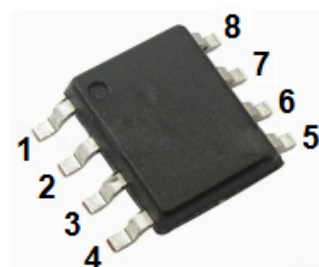
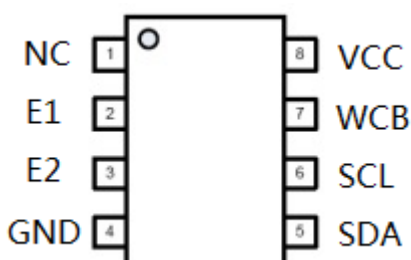

引脚排列 / Pinning

Pin	Name	Type	Description
1	NC	-	悬空
2	E1	Input	从地址设置
3	E2	Input	从地址设置
4	GND	Ground	芯片地
5	SDA	I/O	串行数据输入/输出
6	SCL	Input	串行时钟输入
7	WCB	Input	写入控制, 低电平使能写入
8	VCC	Power	电源脚

印章代码 / Marking

见印章说明 / See Marking Instructions

极限参数 / Absolute Maximum Ratings(Ta=25°C)

参数 Parameter	符号 Symbol	数值 Rating	单位 Unit
Storage Temperature	T _{stg}	-65~+150	°C
Operation Temperature	T _{opr}	-40~+85	°C
Maximum Operation Voltage	V _{cc}	6.25	V
Voltage on Any Pin with Respect to Ground	V _{pin}	-1.0~ (V _{cc} +1.0)	V
DC Output Current	I _{out}	5.0	mA
Electro-Static discharge (HBM mode)	ESD	6000	V

可靠性参数 / Reliability Characteristic

参数 Parameter	符号 Symbol	测试条件 Test Conditions	最小值 Min	典型值 Typ	最大值 Max	单位 Unit
Endurance	EDR	25°C, 3.3V, Page mode	1,000,000			Write cycles
Data retention	DRET		100			Years

直流电性能参数 / DC Electrical Characteristics(Unless otherwise specified, Vcc = 1.7V to 5.5V, TA = -40°C to 85°C)

参数 Parameter	符号 Symbol	测试条件 Test Conditions	最小值 Min	典型值 Typ	最大值 Max	单位 Unit
Supply Voltage	Vcc		1.7		5.5	V
Standby Current	Isb	Vcc = 3.3V, TA = 85°C			1.0	uA
		Vcc = 5.5V, TA = 85°C			3.0	uA
Supply Current	Icc1	Vcc=5.5V, Read at 400Khz		0.2	0.4	mA
Supply Current	Icc2	Vcc=5.5V, Write at 400Khz		0.8	1.6	mA
Input Leakage Current	ILI	VIN = Vcc or GND		0.1	1.0	uA
Output Leakage Current	ILO	VOUT = Vcc or GND		0.05	1.0	uA
Input Low Level	VIL		-0.6		0.3Vcc	V
Input High Level	VIH		0.7Vcc		Vcc+0.5	V
Output Low Level Vcc = 1.7V (SDA)	VOL1	IOL = 1.5 mA			0.2	V
Output Low Level Vcc= 3.0V (SDA)	VOL2	IOL = 2.1 mA			0.4	V

交流电性能参数 / AC Electrical Characteristics(Unless otherwise specified, Vcc = 1.7V to 5.5V, TA = -40°C to 85°)

参数 Parameter	符号 Symbol	1.7V≤Vcc<2.5V			2.5V≤Vcc≤5.5V			单位 Unit
		最小值 Min	典型值 Typ	最大值 Max	最小值 Min	典型值 Typ	最大值 Max	
Clock Frequency, SCL	f _{SCL}	-	-	400	-	-	1000	kHz
Clock Pulse Width Low	t _{LOW}	1.3	-	-	0.4	-	-	us
Clock Pulse Width High	t _{HIGH}	0.6	-	-	0.4	-	-	us
Clock Low to Data Out Valid	t _{AA}	0.05	-	0.9	0.05	-	0.55	us
Noise Suppression Time	t _i	-	-	0.1	-	-	0.05	us
Time the bus must be free before a new transmission can start	t _{BUF}	1.3	-	-	0.5	-	-	us
Start Hold Time	t _{HD.STA}	0.6	-	-	0.25	-	-	us
Start Setup Time	t _{SU.STA}	0.6	-	-	0.25	-	-	us

交流电性能参数 / AC Electrical Characteristics(Unless otherwise specified, Vcc = 1.7V to 5.5V, TA = -40°C to 85°)

参数 Parameter	符号 Symbol	1.7V≤Vcc<2.5V			2.5V≤Vcc≤5.5V			单位 Unit
		最小值 Min	典型值 Typ	最大值 Max	最小值 Min	典型值 Typ	最大值 Max	
Data In Hold Time	t _{HD.DAT}	0	-	-	0	-	-	us
Data In Setup Time	t _{SU.DAT}	0.1	-	-	0.1	-	-	us
Inputs Rise Time[1]	t _R	-	-	0.3	-	-	0.3	us
Inputs Fall Time[1]	t _F	-	-	0.3	-	-	0.1	us
Stop Setup Time	t _{SU.STO}	0.6	-	-	0.25	-	-	us
Data Out Hold Time	t _{DH}	0.05	-	-	0.05	-	-	us
WCB pin Setup Time	t _{SU.WCB}	1.2	-	-	0.6	-	-	us
WCB pin Hold Time	t _{HD.WCB}	1.2	-	-	0.6	-	-	us
Write Cycle Time	t _{WR}	-	-	5	-	-	5	ms

Notes:AC measurement conditions:

1. RL (connects to Vcc): 1.3k (2.5V, 5.5V), 10k (1.7V)
2. Input pulse voltages: 0.3 Vcc to 0.7 Vcc
3. Input rise and fall times: ≤50ns
4. Input and output timing reference voltages: 0.5Vcc

原理框图 / Functional Block Diagram

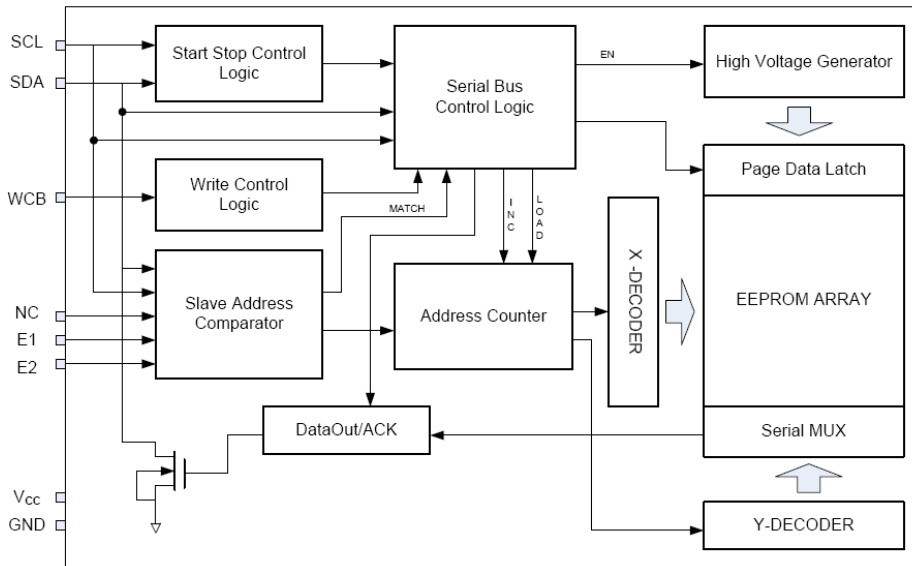

功能描述 / Functional Description

◆ 数据输入 / Data Input

SDA 引脚通常用外部设备拉高。SDA 引脚上的数据只能在 SCL 低电平时更改(如图 1 所示)。SCL 高电平期间的 SDA 数据改变，将产生起始信号或停止信号(如图 1 所示)：

The SDA pin is normally pulled high with an external device. Data on the SDA pin may change only during SCL low time periods (see to Figure 1). Data changes during SCL high periods will indicate a start or stop condition as defined below.

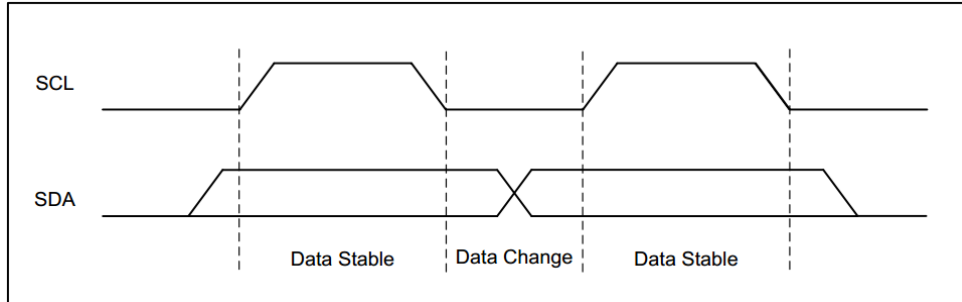

Figure 1 Data Validity

◆ 起始信号 / Start Condition

当 SCL 为高电平时，SDA 下降沿（高电平转为低电平）作为起始信号，起始信号先于其他操作。（如图 2 所示）

A high-to-low transition of SDA with SCL high is a start condition which must precede any other command (see to Figure 2).

◆ 停止信号 / Stop Condition

当 SCL 为高电平时，SDA 上升沿（低电平转为高电平）作为停止信号。读序列之后，停止命令使 BRCM24C04SC 置于待机功耗模式。

A low-to-high transition of SDA with SCL high is a stop condition. After a read sequence, the stop command will place the BRCM24C04SC in a standby power mode (see Figure 2).

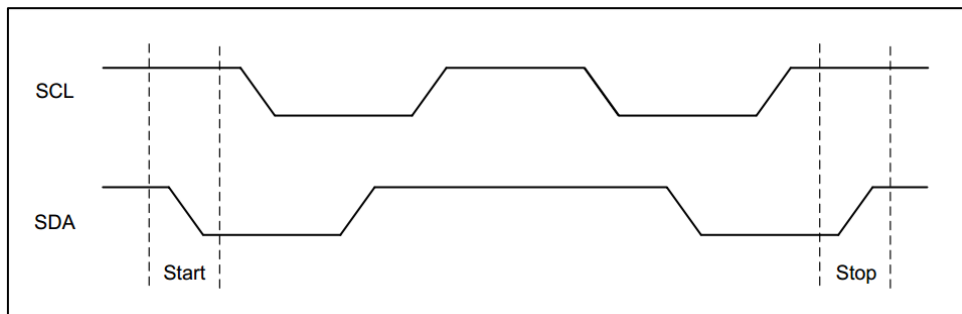

Figure 2 Start and Stop Definition

◆ 应答信号 (ACK) / Acknowledge

每当一个地址或数据字节以串行方式发送到 BRCM24C04SC 后，BRCM24C04SC 发送一个“0”表示收到了这个字节，应答 (ACK) 发生在第 9 个时钟周期。

功能描述 / Functional Description

All addresses and data words are serially transmitted to and from the BRCM24C04SC in 8-bit words. The BRCM24C04SC sends a “0” to acknowledge that it has received each word. This happens during the ninth clock cycle.

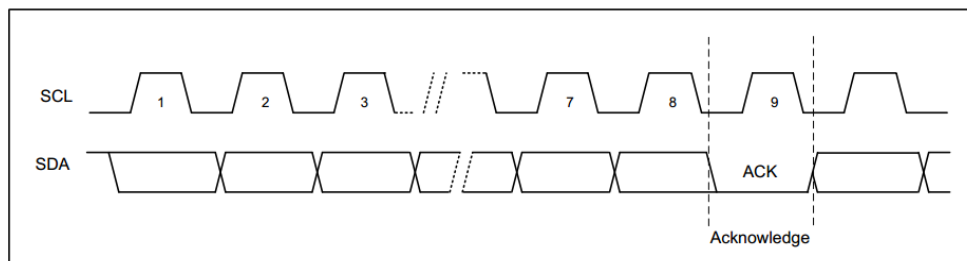

Figure 3 Output Acknowledge

◆ 待机模式 / Standby Mode

BRCM24C04SC 具有低功耗待机模式，该模式出现在:(a)在重新上电后,(b)在读取模式下接收一个停止位后,(c)完成一个内部自定时编程操作后。

The BRCM24C04SC features a low-power standby mode which is enabled: (a) after a fresh power up, (b) after receiving a STOP bit in read mode, and (c) after completing a self-time internal programming operation.

◆ 软件复位 / Soft Reset

在协议、断电丢失或系统复位中断后，可以通过以下步骤重置任何双线部件：(a)创建一个开始条件,(b)九个时钟周期,(c)创建另一个起始位信号紧随停止位信号，如图 4 所示。在完成上述步骤后，设备已准备好进行下一次通信。

After an interruption in protocol, power loss or system reset, any two-wire part can be reset by following these steps: (a) Create a start condition, (b) Clock nine cycles, and (c) create another start bit followed by stop bit condition, as Figure 4 . The device is ready for the next communication after the above steps have been completed.

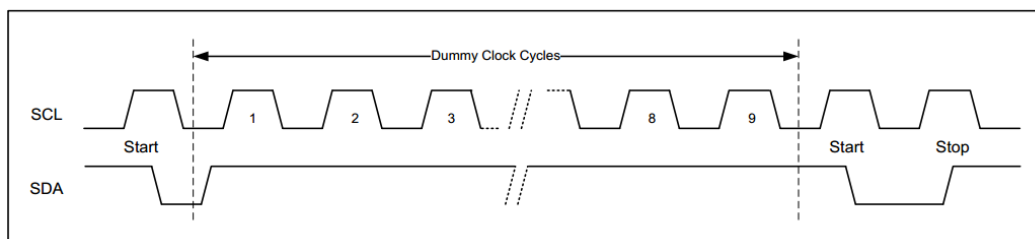

Figure 4 Soft Reset

◆ 器件寻址 / Device Addressing

BRCM24C04SC 在启动条件后需要一个 8 位器件地址字，以使芯片能够进行读或写操作（如表 1 所示）。器件地址字前四位为固定 1、0 序列。

The BRCM24C04SC requires an 8-bit device address word following a start condition to enable the chip for a read or write operation (see table 1). The device address word consists.

功能描述 / Functional Description

Chip	Access area	Bit 7	Bit 6	Bit 5	Bit 4	Bit 3	Bit 2	Bit 1	Bit 0
BRCM24C04S C	Normal Area	1	0	1	0	E2	E1	P0	R/W
	ID Page	1	0	1	1	E2	E1	X	R/W
	Lock Bit	1	0	1	1	E2	E1	X	R/W
	Serial Number	1	0	1	1	E2	E1	X	1

Table 1 Device Address

Chip	Access area	Bit 7	Bit 6	Bit 5	Bit 4	Bit 3	Bit 2	Bit 1	Bit 0
BRCM24C04S C	Normal Area	A7	A6	A5	A4	A3	A2	A1	A0
	ID Page	0	0	A5	A4	A3	A2	A1	A0
	Lock Bit	X	1	X	X	X	X	X	X
	Serial Number	1	0	A5	A4	A3	A2	A1	A0

Table 2 Word Address

E2、E1 设备地址位允许在同一总线上有最多达 4 个设备，并且与硬件引脚连接相对应。E2、E1 如果引脚是浮动的，内部电路会使它们拉到逻辑低电位，设备地址的第 8 位是读/写操作选择位。如果这个位置 0，选择写操作，如果这个位置 1，选择读操作。如果地址正确，芯片将输出一个 0 进行应答。如果地址不正确，设备将进入到待机状态。

The E2, E1 device address bits to allow as many as 4 devices on the same bus. These bits must compare to their corresponding hardwired input pins. The E2, E1 pins use an internal proprietary circuit that biases them to a logic low condition if the pins are floating. The eighth bit of the device address is the read/write operation select bit. A read operation is initiated if this bit is high and a write operation is initiated if this bit is low. Upon a compare of the device address, the Chip will output a zero. If a compare is not made, the device will return to a standby state.

◆ 数据保护 / Data Security

BRCM24C04SC 有一个写保护位 WCB，当其接 Vcc 时，器件禁止写操作，以保护内部数据。

BRCM24C04SC has a hardware data protection scheme that allows the user to write protect the whole memory when the WCB pin is at Vcc.

◆ 字节写 / Byte Write

一个写操作需要一个 8 位的数据字节地址跟随在设备地址后，以及一个应答位。在接收到地址数据后，BRCM24C04SC 将再次发送“0”作为响应，然后开始第一个 8 位数据的时钟。在接收到 8 位数据字之后，BRCM24C04SC 将再次发送一个“0”和寻址设备，单片机产生停止信号终止写序列。接着 BRCM24C04SC 进入内部计时写循环，在写循环期间所有输入都被禁用，BRCM24C04SC 在写操作完成之前不会响应，(如图 5 所示)。

A write operation requires one 8-bit data word address following the device address word and acknowledgment. Upon receipt of this address, the BRCM24C04SC will again respond with a “0” and then clock in the first 8-bit data word. Following receipt of the 8-bit data word, the BRCM24C04SC will output a “0” and the addressing device, such as a microcontroller, must terminate the write sequence with a stop condition. And then the BRCM24C04SC enters an internally timed write cycle, all inputs are disabled during this write cycle and the BRCM24C04SC will not respond until the write is complete (see Figure 5).

功能描述 / Functional Description

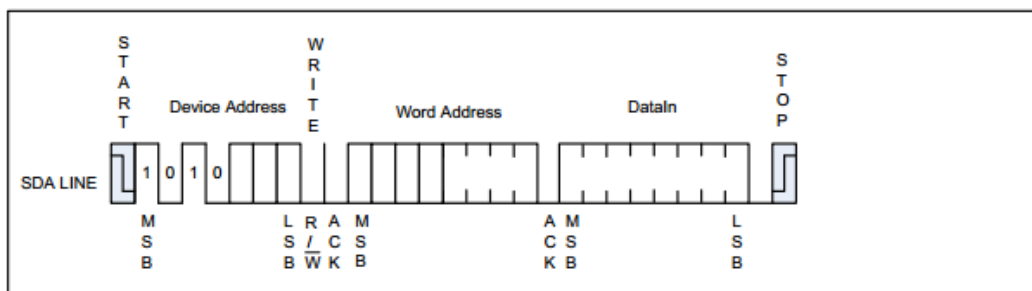

Figure 5 Byte Write

◆ 页写 / Page Write

页面写操作与字节写操作相同，但是单片机在第一次写操作之后不会发送停止条件。在确认 BRCM24C04SC 收到第一个字节数据后，单片机可以继续传输更多的数据字。BRCM24C04SC 每收到一个数据字节后，都会产生一个“0”作为应答。单片机可以通过产生停止信号来终止页写操作。

A page write is initiated the same as a byte write, but the master does not send a stop condition after the first data word is clocked in. Instead, after the BRCM24C04SC acknowledges receipt of the first data word, the master can transmit more data words. The BRCM24C04SC will respond with a “0” after each data word received. The microcontroller must terminate the page write sequence with a stop condition.

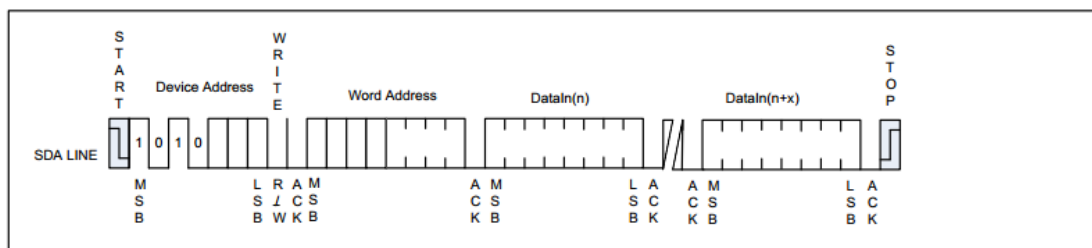

Figure 6 Page Write

在接收到每个数据字之后，数据字地址的低 4 位在内部递增。较高数据字地址位不递增，保留存储器页行位置。当内部生成的字地址到达页边界时，后面的字节放在同一页的开头。如果发送到 BRCM24C04SC 的数据字超过 16 个，则数据字地址将翻转，之前的数据将被覆盖。页写操作期间的地址翻转是从当前页面的最后一个字节到同一页面的第一个字节。

The lower four bits of the data word address are internally incremented following the receipt of each data word. The higher data word address bits are not incremented, retaining the memory page row location. When the word address, internally generated, reaches the page boundary, the following byte is placed at the beginning of the same page. If more than 16 data words are transmitted to the BRCM24C04SC, the data word address will roll-over, and previous data will be overwritten. The address roll-over during write is from the last byte of the current page to the first byte of the same page.

功能描述 / Functional Description**◆ 应答轮询 / Acknowledge Polling**

一旦内部定时写周期开始并禁用 BRCM24C04SC 输入，就可以启动应答轮询。这包括发送一个起始信号跟在设备地址字节后面，读/写位代表所需的操作。只有在内部写周期完成后，BRCM24C04SC 才会响应“0”，允许读或写序列继续。

Once the internally timed write cycle has started and the BRCM24C04SC inputs are disabled, acknowledge polling can be initiated. This involves sending a start condition followed by the device address word. The read/write bit is representative of the operation desired. Only if the internal write cycle has completed will the BRCM24C04SC respond with a “0”, allowing the read or write sequence to continue.

◆ 写标识页面 / Write Identification Page

标识页(16 字节)是一个附加页面，可以在只读模式下写入并永久锁定。它由写标识页面指令写入。该指令使用与页写(内存阵列)具有相同的协议和格式，但有以下区别：

(a)设备类型标识：1011b；

(b)地址位 A5 / A4 任意 0 或 1 组合，地址位 A7 / A6 必须为“00”；

(c)地址位 A3 / A0 定义标识页面内的字节地址。如果标识页面是锁定的，在写标识页面指令期间传输的数据字节不会被应答(NoACK)。

The Identification Page (16 bytes) is an additional page which can be written and (later) permanently locked in Read-only mode. It is written by the Write Identification Page instruction. This instruction uses the same protocol and format as Page Write (into memory array), except for the following differences:

(a)Device type identifier = 1011b.

(b)Address bits A5/A4 are don't care while address bit A7/A6 which must be '00'.

(c)Address bits A3/A0 define the byte address inside the Identification page. If the Identification page is locked, the data bytes transferred during the Write Identification Page instruction are not acknowledged (NoACK).

◆ 锁定标识页面 / Lock Identification Page

锁定标识页面指令(锁定 ID)永久锁定标识页面在只读模式下进行。Lock ID 指令类似于字节写(内存阵列)，具体条件如下：

(a)设备类型标识：1011b;

(b)地址位 A6 为 1，其他位任意;

(c)数据字节必须等于二进制值 xxxx xx1x，其中 x 为任意 0 或 1。

The Lock Identification Page instruction (Lock ID) permanently locks the Identification page in Read-only mode. The Lock ID instruction is similar to Byte Write (into memory array) with the following specific conditions:

(a)Device type identifier = 1011b.

(b)Address bit A6 must be '1', all other address bits are don't care.

(c)The data byte must be equal to the binary value xxxx xx1x, where x is don't care.

功能描述 / Functional Description

◆ 读操作 / Read Operations

除了读/写选择位之外，读操作的启动方式与写操作相同，读操作中器件地址的读/写位设置“1”。读操作有三种模式：当前地址读取；随机地址读取和顺序读取。

Read operations are initiated the same way as write operations with the exception that the read/write select bit in the device address word is set to “1”. There are three read operations: Current Address Read; Random Address Read and Sequential Read.

◆ 当前地址读取 / Current Address Read

内部数据字地址计数器在保持上次读取或写入期间访问的最后一个地址操作基础上递增 1。在两次操作之间，只要芯片的供电维持，该地址维持有效。读取期间的地址翻转是从最后一个存储器页面的最后一个字节到第一个存储页的第一个字节。一旦将读/写位为“1”的器件地址输入并由 BRCM24C04SC 确认，当前地址数据字串行输出。微控制器不响应“0”，但会产生一个跟随停止信号（如图 7 所示）。
The internal data word address counter maintains the last address accessed during the last read or write operation, incremented by one. This address stays valid between operations as long as the chip power is maintained. The address roll-over during read is from the last byte of the last memory page to the first byte of the first page. Once the device address with the read/write select bit set to “1” is clocked in and acknowledged by the BRCM24C04SC, the current address data word is serially clocked out. The microcontroller does not respond with an input “0” but does generate a following stop condition (see Figure7).

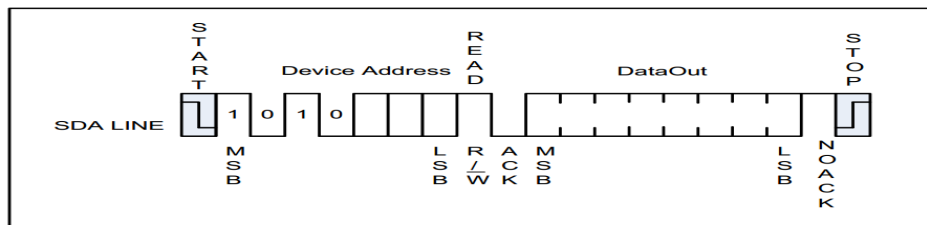

Figure 7 Current Address Read

◆ 随机地址读取 / Random Address Read

随机读取需要“伪”字节写序列来加载数据字地址。一旦设备地址字和数据地址字输入并由 BRCM24C04SC 确认，微控制器必须产生另一个启动条件。微控制器立即通过发送读/写选择位为高的器件地址来启动当前地址读操作。BRCM24C04SC 确认器件地址并串行输出数据字。微控制器不响应“0”，但会产生一个跟随停止信号（如图 8 所示）。

A Random Read requires a “dummy” byte write sequence to load in the data word address. Once the device address word and data word address are clocked in and acknowledged by the BRCM24C04SC, the microcontroller must generate another start condition. The microcontroller now initiates a Current Address Read by sending a device address with the read/write select bit high. The BRCM24C04SC acknowledges the device address and serially clocks out the data word. The microcontroller does not respond with a “0” but does generate a following stop condition (see Figure 8).

功能描述 / Functional Description

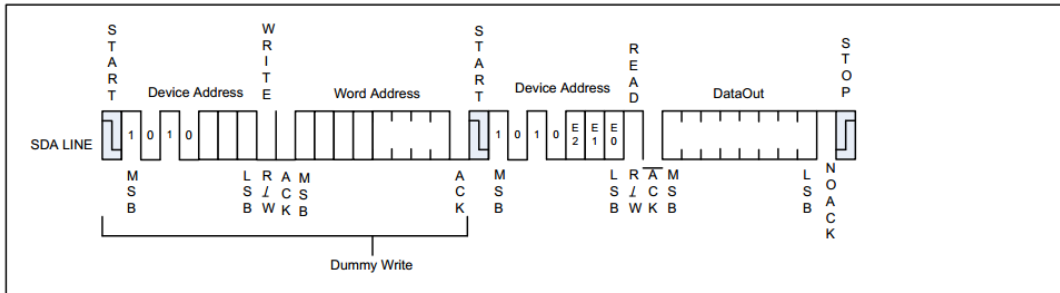

Figure 8 Random Address Read

◆ 顺序读取 / Sequential Read

顺序读取由当前地址读取或随机地址读取启动。微控制器接收数据字，之后器件通过应答响应。只要 BRCM24C04SC 接收到应答，它将继续递增数据字地址和串行输出顺序数据字节。当达到内存地址限制时，数据字地址将翻转，顺序读取将继续。当微控制器没有响应“0”但产生一个停止信号时，顺序读取操作终止（如图 9 所示）。

Sequential Reads are initiated by either a Current Address Read or a Random Address Read. After the microcontroller receives a data word, it responds with acknowledge. As long as the BRCM24C04SC receives acknowledge, it will continue to increment the data word address and serially clock out sequential data words. When the memory address limit is reached, the data word address will roll-over and the Sequential Read will continue. The Sequential Read operation is terminated when the microcontroller does not respond with a “0” but does generate a following stop condition (see Figure 9).

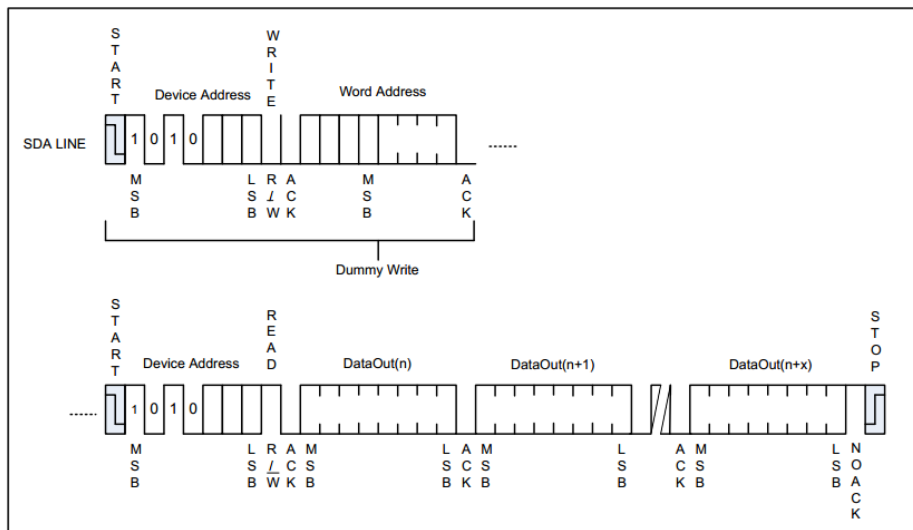

Figure 9 Sequential Read

功能描述 / Functional Description

◆ 读取标识页 / Read Identification Page

标识页 (16 字节) 是一个附加页面，可以在只读模式下写入并永久锁定。识别页面可以通过读取识别页面指令读取，该指令使用与读命令 (来自存储器阵列) 有相同的协议和格式，设备类型标识符定义为 1011b。地址位 A7 / A6 必须为 0，而 A5 任意，地址位 A4 / A0 定义标识页内的字节地址。ID 页面中要读取的字节数不得超过页面边界 (例如，从位置 10d 读取标识页时，字节数应小于或等于 6，因为 ID 页边界为 16 字节)。

The Identification Page (16 bytes) is an additional page which can be written and (later) permanently locked in Read-only mode. The Identification Page can be read by Read Identification Page instruction which uses the same protocol and format as the Read Command (from memory array) with device type identifier defined as 1011b. The MSB address bits A7/A6 must be 0 while A5 is don't care, and the LSB address bits A4/A0 define the byte address inside the Identification Page. The number of bytes to read in the ID page must not exceed the page boundary (e.g. when reading the Identification Page from location 10d, the number of bytes should be less than or equal to 6, as the ID page boundary is 16 bytes).

◆ 读取锁定状态 / Read the Lock Status

可以通过向设备发送特定截断命令 [标识页写入指令 + 一个数据字节] 来检查标识页面的锁定/解锁状态。如果识别页面未锁定，则设备返回 ACK，如果识别页面被锁定，则设备返回 NoACK (如图 10 所示)。

The locked/unlocked status of the Identification page can be checked by transmitting a specific truncated command [Identification Page Write instruction + one data byte] to the device. The device returns an acknowledge bit if the Identification page is unlocked, otherwise a NoACK bit if the Identification page is locked (see Figure 10).

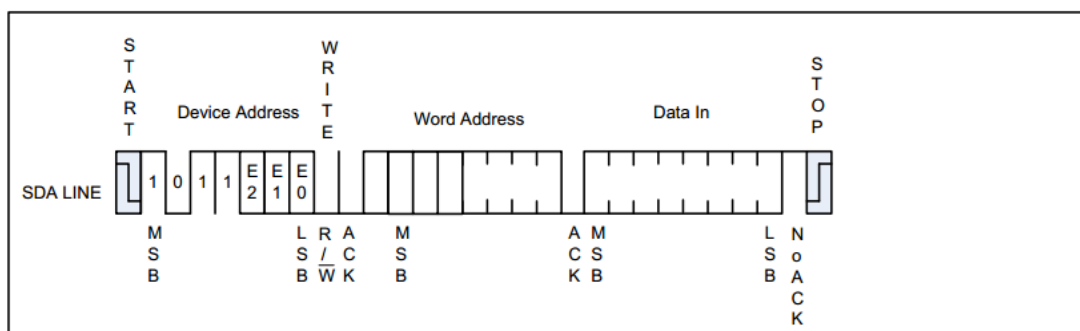

Figure 10 Lock Status Read (When Identification page locked, return NoACK after one data byte)

◆ 读取序列号 / Read Serial Number

标识页 (16 字节) 是一个附加页面，可以在只读模式下写入并永久锁定。

读取序列号类似于顺序读取序列，但需要使用的表 1 中所示的器件地址，虚拟写入以及使用一个特定的字节地址。必须从序列号块的起始地址读取整个 128 位值，以保证唯一的编号。

由于器件的地址指针在常规 EEPROM 阵列和序列号块之间共享，因此应执行“伪写”序列，作为随机读或顺序读协议的一部分，以确保地址指针设置为零。如果先前的操作是 EEPROM 阵列，序列号块是支持当前地址读取的，地址指针将在访问的最后一个位置上增加 1。从序列号块的第一个地址以外的位置读取序列号，会导致产生的序列号不唯一。

功能描述 / Functional Description

此外，序列号的字地址 A7 和 A6 位序列为“10”，如表 2 中所示的预设地址。如果使用“10”以外的字地址，那么设备将输出未定义的数据。（示例：如果应用程序希望读取序列号的第一个字节，则字地址输入需要为 80h）。

当达到 128 位（16 字节数据）序列号的末尾时，继续读取扩展存储区将导致重复的序列号数据读出，数据字地址将翻转回到 128 的开头位序列号字地址。当微控制器没有响应零（ACK）时，序列号读操作终止并发出停止条件（见图 7）。

The Identification Page (16 bytes) is an additional page which can be written and (later) permanently locked in Read-only mode.

Reading the serial number is similar to the sequential read sequence but requires use of the device address seen in Table 1 on page 9, a dummy write, and the use of a specific word address. The entire 128-bit value must be read from the starting address of the serial number block to guarantee a unique number.

Since the address pointer of the device is shared between the regular EEPROM array and the serial number block, a dummy write sequence, as part of a Random Read or Sequential Read protocol, should be performed to ensure the address pointer is set to zero. A Current Address Read of the serial number block is supported but if the previous operation was to the EEPROM array, the address pointer will retain the last location accessed, incremented by one. Reading the serial number from a location other than the first address of the block will not result in a unique serial number.

Additionally, the word address contains a „10□ sequence in bit A7 and A6 of the word address, regardless of the intended address as depicted in Table 2 on page 9. If a word address other than „10□ is used, then the device will output undefined data.

Example: If the application desires to read the first byte of the serial number, the word address input would need to be 80h.

When the end of the 128-bit serial number is reached (16 bytes of data), continued reading of the extended memory region will result in repeated serial number data readout for the data word address will roll-over back to the beginning of the 128-bit serial number. The Serial Number Read operation is terminated when the microcontroller does not respond with a zero (ACK) and instead issues a Stop condition (see Figure 11)

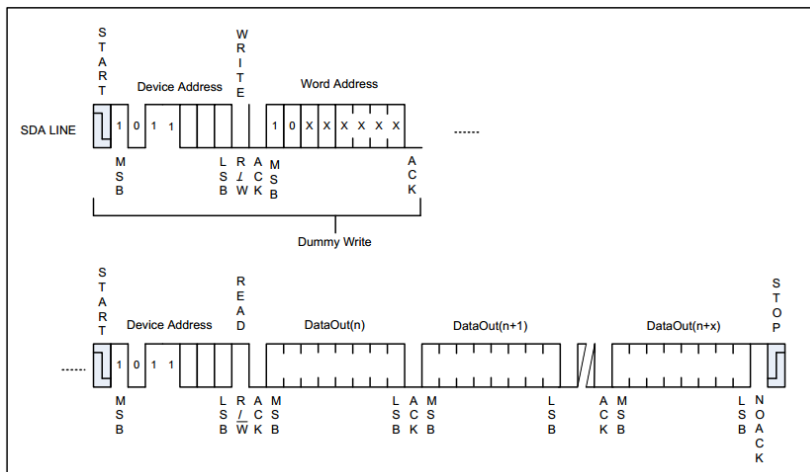
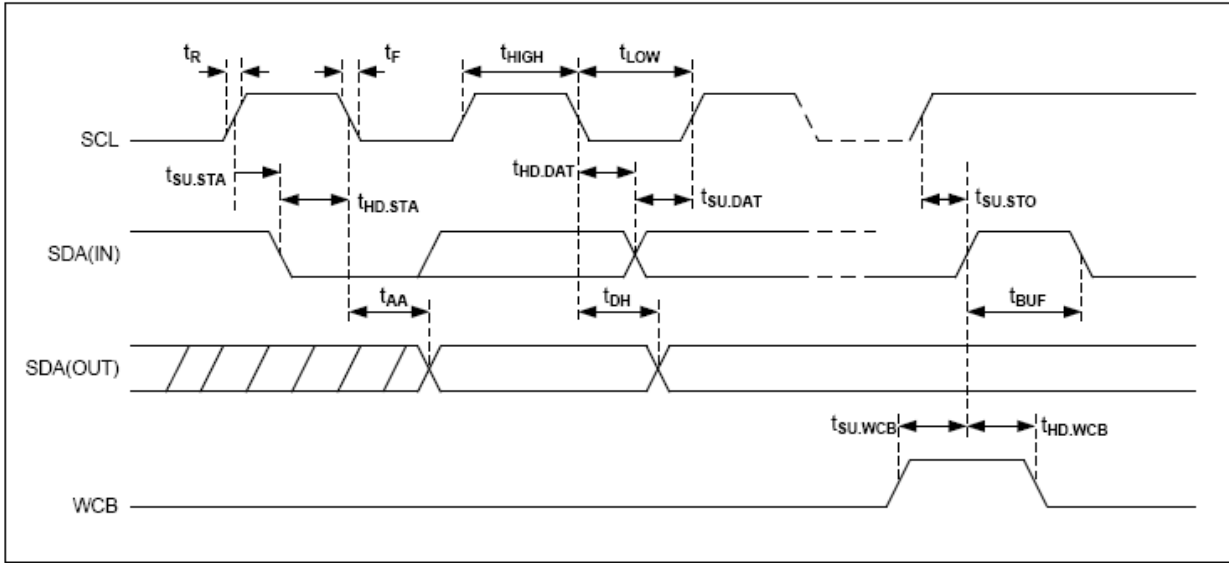

Figure 11 Sequential Read

时序图 / Time Sequence Diagram

Bus Timing



Write Cycle Timing

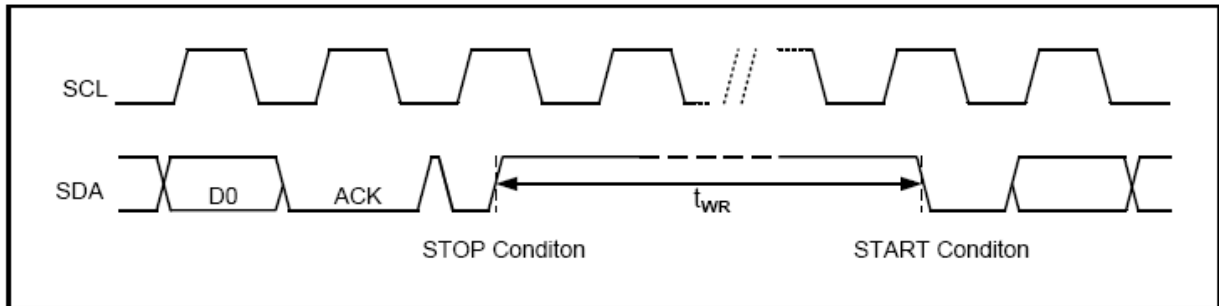

Note: The write cycle time t_{WR} is the time from a valid stop condition of a write sequence to the end of the internal clear/write cycle.

外形尺寸图 / Package Dimensions

SOP-8

Unit:mm

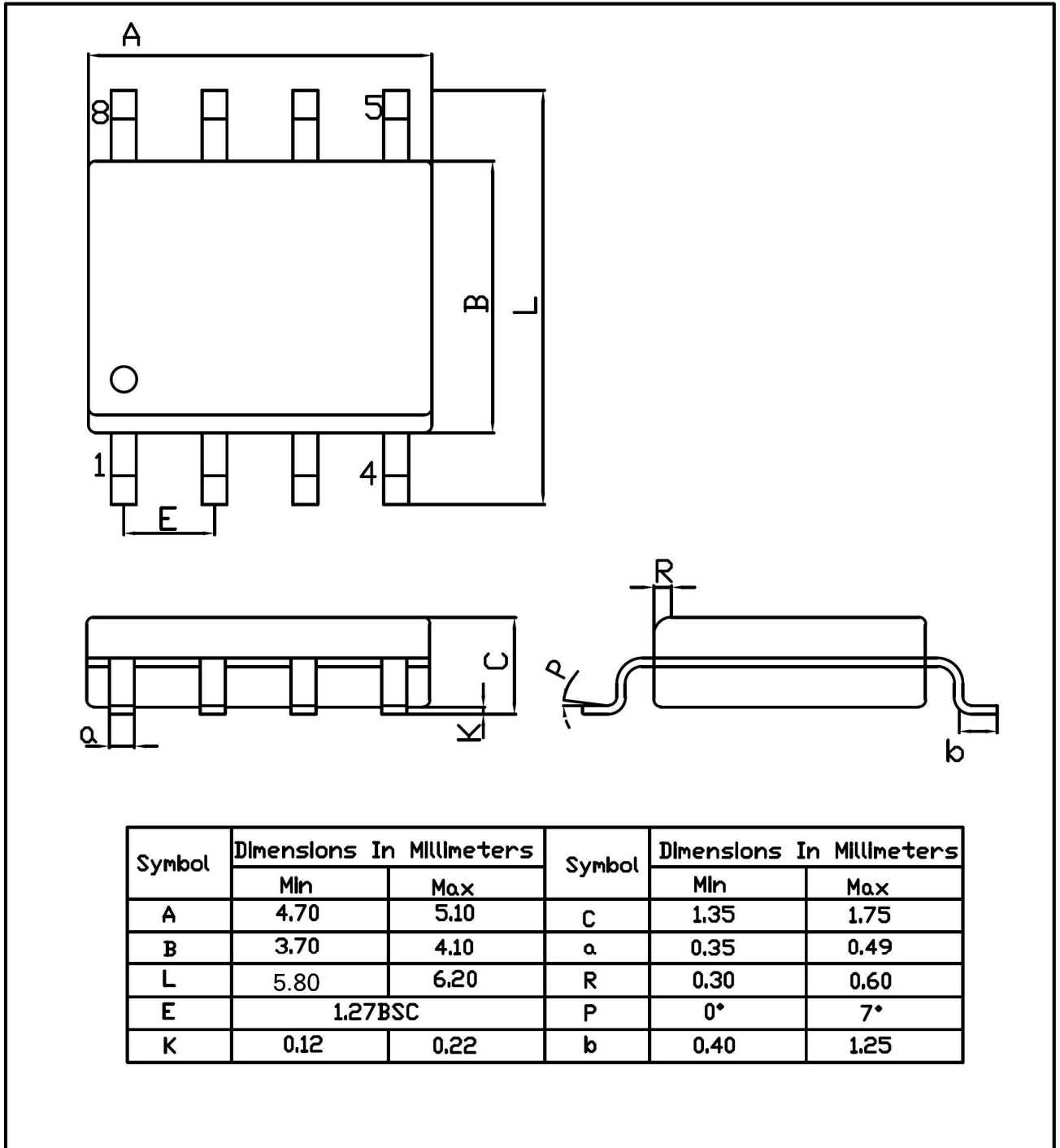

印章说明 / Marking Instructions

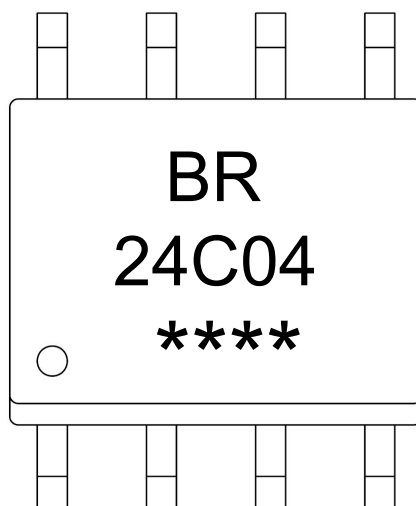

说明：

BR： 为公司代码

24C04： 为型号代码

****： 为生产批号代码，随生产批号变化

Note:

BR: Company Code.

24C04: Product Type.

****: Lot No. Code, code change with Lot No.

回流焊温度曲线图(无铅) / Temperature Profile for IR Reflow Soldering(Pb-Free)

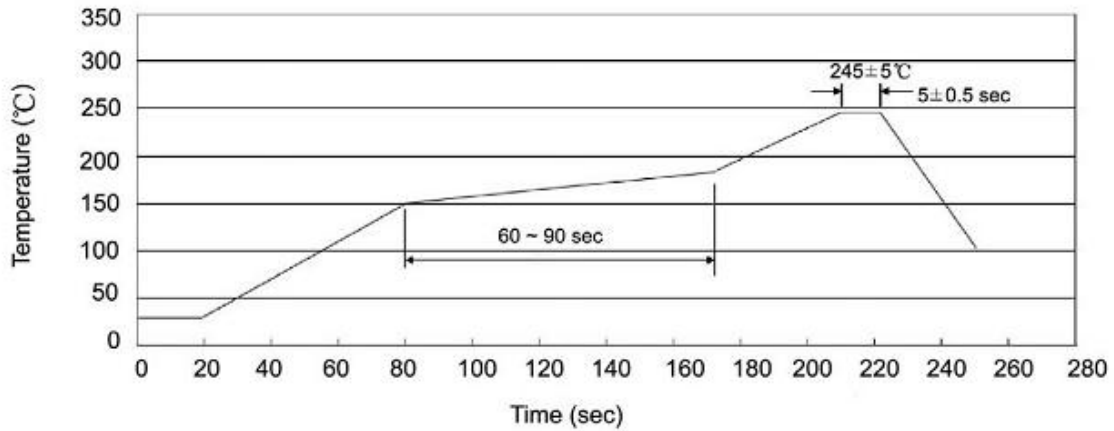

说明：

- 1、预热温度 150 ~ 180°C，时间 60 ~ 90sec;
- 2、峰值温度 245±5°C，时间持续为 5±0.5sec;
- 3、焊接制程冷却速度为 2 ~ 10°C/sec.

Note:

- 1.Preheating:150~180°C, Time:60~90sec.
- 2.Peak Temp.:245±5°C, Duration:5±0.5sec.
3. Cooling Speed: 2~10°C/sec.

耐焊接热试验条件 / Resistance to Soldering Heat Test Conditions

温度：260±5°C

时间：10±1 sec.

Temp.:260±5°C

Time:10±1 sec

包装规格 / Packaging SPEC.

卷盘包装 / REEL

Package Type 封装形式	Units 包装数量					Dimension 包装尺寸 (unit: mm ³)		
	Units/Reel 只/卷盘	Reels/Inner Box 卷盘/盒	Units/Inner Box 只/盒	Inner Boxes/Outer Box 盒/箱	Units/Outer Box 只/箱	Reel	Inner Box 盒	Outer Box 箱
SOP/ESOP-8	4,000	2	8,000	6	48,000	13" ×12	360×360×50	380×335×366

使用说明 / Notices