

BRCS40P03IP

Rev.A Sep.-2022

描述 / Descriptions

P 沟道 TO-251 塑封封装场效应管。

P-CHANNEL MOSFET in a TO-251 Plastic Package.

特征 / Features

$R_{DS(on)}$ 小, 大电流输出能力, 无卤产品。

Low $R_{DS(on)}$, High Current Capability, HF Product.

用途 / Applications

交流负载开关, 蓄电池充电/放电保护。

AC-in load switch, Battery protection charge/discharge.

内部等效电路 / Equivalent Circuit

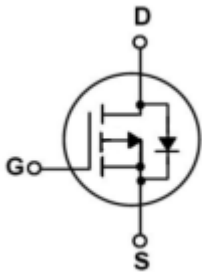

引脚排列 / Pinning

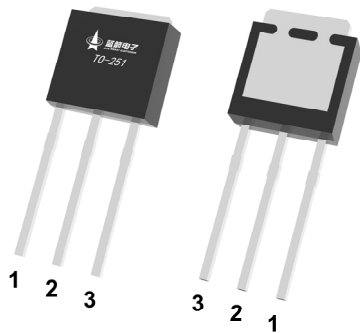

PIN1 : G

PIN 2 : D

PIN 3 : S

印章代码 / Marking

见印章说明。

See Marking Instructions.

极限参数 / Absolute Maximum Ratings(Ta=25°C)

参数 Parameter	符号 Symbol	数值 Rating	单位 Unit
Drain-Source Voltage	V _{DSS}	-30	V
Drain Current	I _D (Tc=25°C)	-55	A
Drain Current - Pulsed	I _{DM}	-150	A
Gate-Source Voltage	V _{GS}	±20	V
Avalanche Current	I _{AS}	23.5	A
Avalanche energy L=0.5mH	E _{AS}	662.7	mJ
Power Dissipation	P _D (Tc=25°C)	44	W
	P _D (Tc=100°C)	17	W
Junction and Storage Temperature Range	T _J , T _{stg}	-55~150	°C
Maximum Junction-to-Ambient	t ≤ 10s	R _{θJA}	11
Maximum Junction-to-Ambient	Steady-State		29
Maximum Junction-to-Case	Steady-State	R _{θJC}	2.8

电性能参数 / Electrical Characteristics(Ta=25°C)

参数 Parameter	符号 Symbol	测试条件 Test Conditions	最小值 Min	典型值 Typ	最大值 Max	单位 Unit
Drain-Source Breakdown Voltage	BV _{DSS}	V _{GS} =0V I _D =-250μA	-30	-37		V
Zero Gate Voltage Drain Current	I _{DSS}	V _{DS} =-30V V _{GS} =0V			-1.0	μA
		V _{DS} =-30V V _{GS} =0V T _J =55°C			-5.0	μA
Gate-Body Leakage Current Forward	I _{GSS}	V _{GS} =±20V V _{DS} =0V			±0.1	μA
Gate Threshold Voltage	V _{GS(th)}	V _{DS} =V _{GS} I _D =250μA	-1	-1.5	-2.5	V
Static Drain-Source On-Resistance	R _{DS(on)1}	V _{GS} =-10V I _D =-30A		9.3	10.5	mΩ
	R _{DS(on)2}	V _{GS} =-4.5V I _D =-20A		13.5	14.5	mΩ
Diode Forward Voltage	V _{SD}	I _S =-1A V _{GS} =0V		-0.7	-1.2	V

电性能参数 / Electrical Characteristics(Ta=25°C)

参数 Parameter	符号 Symbol	测试条件 Test Conditions	最小值 Min	典型值 Typ	最大值 Max	单位 Unit
Input Capacitance	C_{iss}	$V_{DS}=-25V$ $V_{GS}=0V$ $f=1.0MHz$		2450		pF
Output Capacitance	C_{oss}			93		
Reverse Transfer Capacitance	C_{rss}			5		
Gate resistance	R_g	$V_{GS}=0V$ $V_{DS}=0V$ $f=1MHz$		6.4		Ω
Total Gate Charge	$Q_g(10V)$	$V_{GS}=-10V$ $V_{DS}=-15V$ $I_D=-20A$		50	70	nC
Total Gate Charge	$Q_g(4.5V)$			25	35	
Gate Source Charge	Q_{gs}			9		
Gate Drain Charge	Q_{gd}			12		
Turn-On Delay Time	$t_{d(on)}$	$V_{GS}=-10V$ $V_{DS}=-15V$ $R_L=0.75\Omega$ $R_{GEN}=3\Omega$		12.5		ns
Turn-On Rise Time	t_r			18		
Turn-Off Delay Time	$t_{d(off)}$			125		
Turn-Off Fall Time	t_f			66		
Body Diode Reverse Recovery Time	t_{rr}	$I_F=-20A$ $di/dt=500A/ms$		32		ns
Body Diode Reverse Recovery Charge	Q_{rr}	$I_F=-20A$ $di/dt=500A/ms$		62		nC

电参数曲线图 / Electrical Characteristic Curve

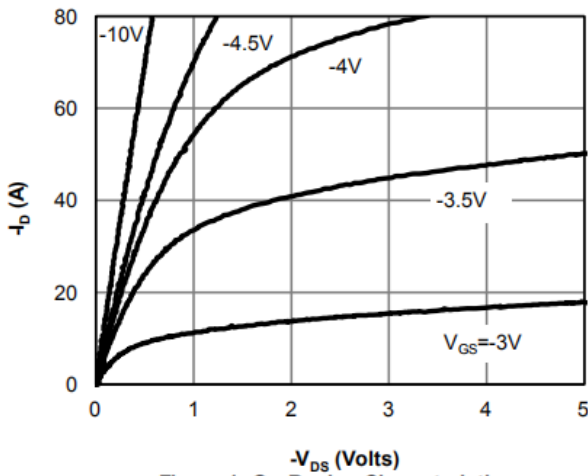

Figure 1: On-Region Characteristics

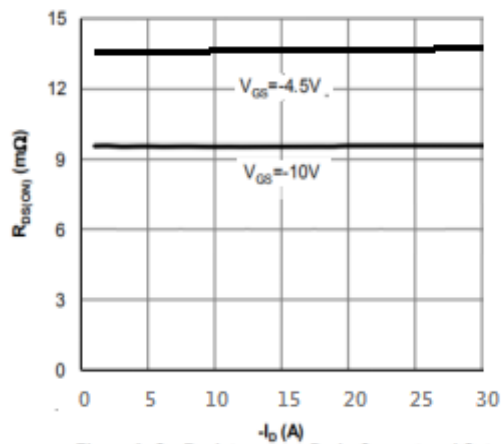
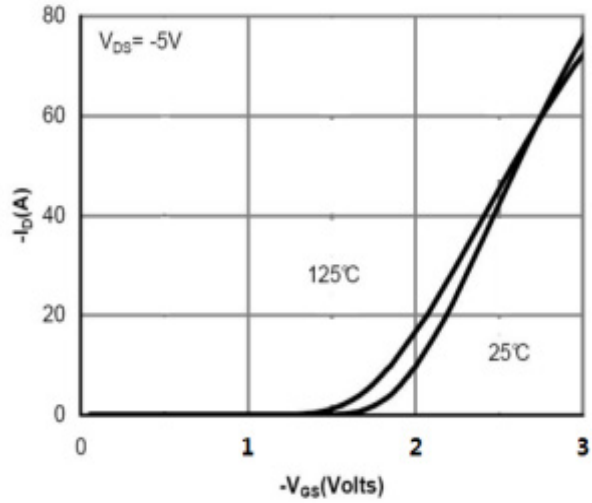

Figure 3: On-Resistance vs. Drain Current and Gate Voltage

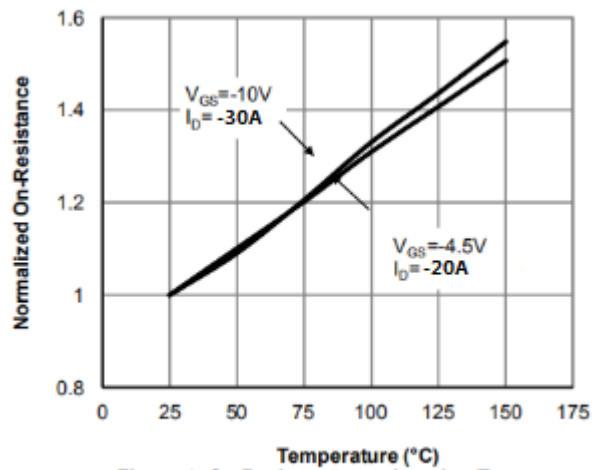

Figure 4: On-Resistance vs. Junction Temperature

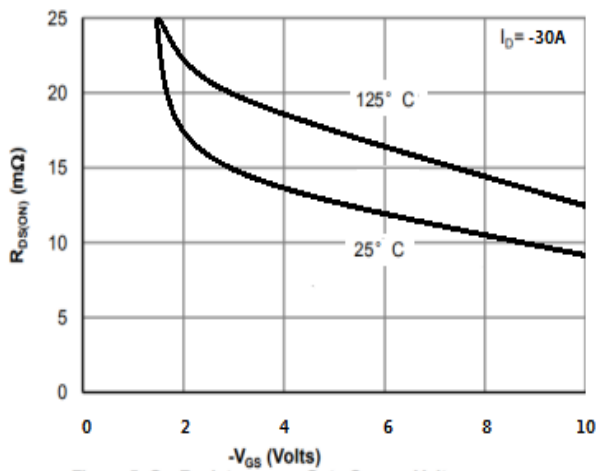

Figure 5: On-Resistance vs. Gate-Source Voltage

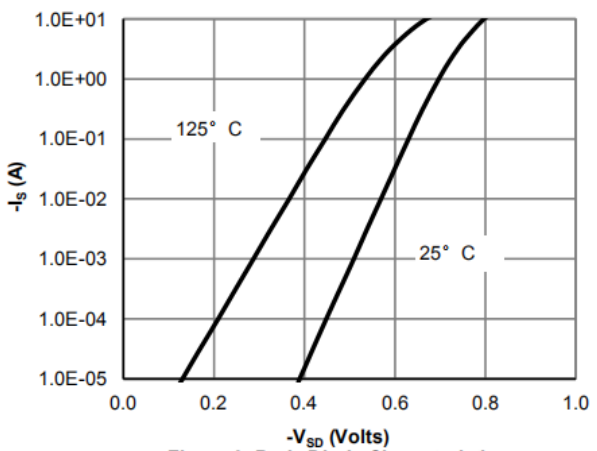

Figure 6: Body-Diode Characteristics

电参数曲线图 / Electrical Characteristic Curve

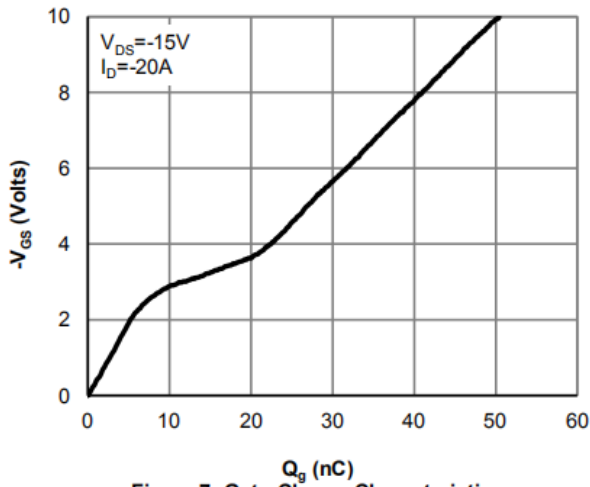

Figure 7: Gate-Charge Characteristics

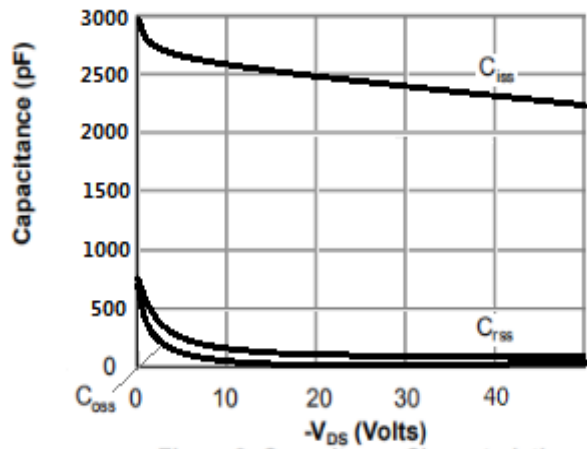

Figure 8: Capacitance Characteristics

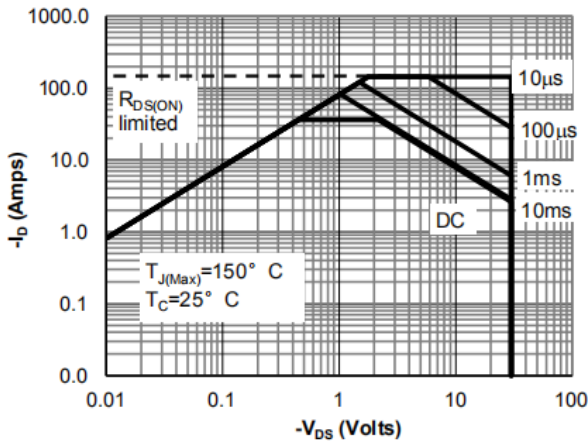

Figure 9: Maximum Forward Biased Safe Operating Area

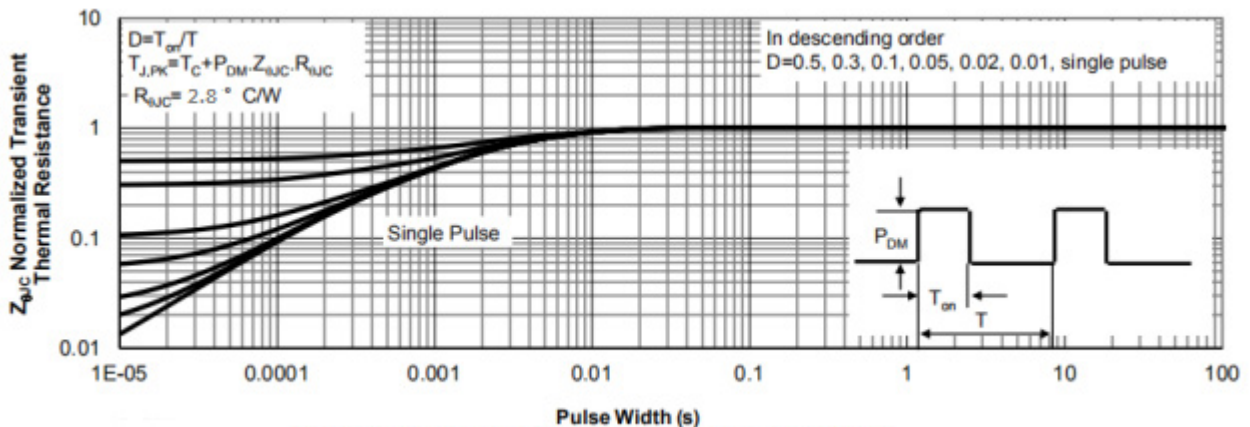
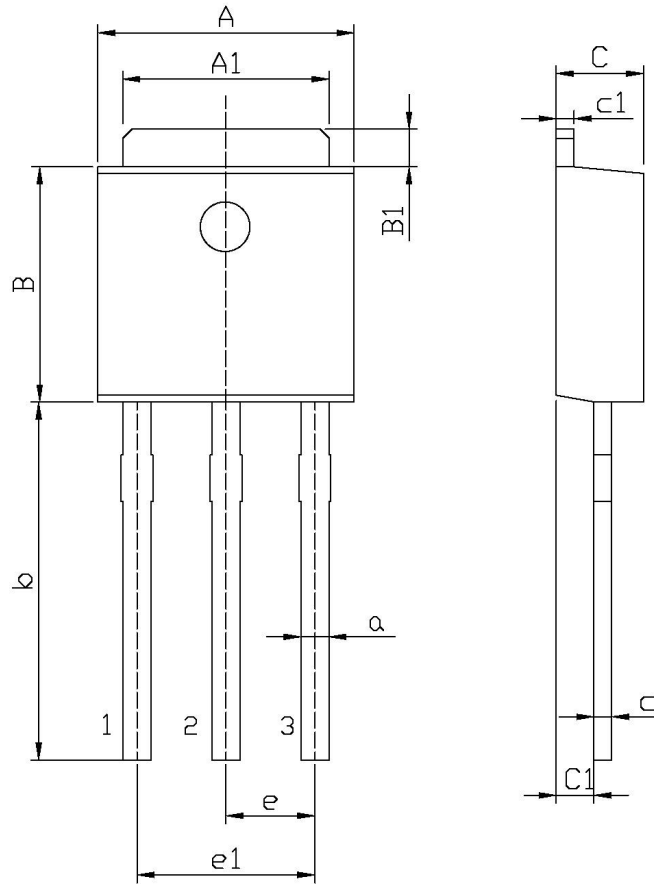

Figure 10: Normalized Maximum Transient Thermal Impedance

外形尺寸图 / Package Dimensions



单位: mm

Symbol	Dimensions In Millimeters		Symbol	Dimensions In Millimeters	
	Min	Max		Min	Max
A	6.45	6.75	a	0.50	0.90
A1	5.10	5.50	b	9.00	9.40
B	5.95	6.25	c	0.45	0.55
B1	0.95	1.25	c1	0.45	0.55
C	2.20	2.40	e	2.24	2.34
C1	0.95	1.15	e1	4.43	4.73

TO-251

印章说明 / Marking Instructions

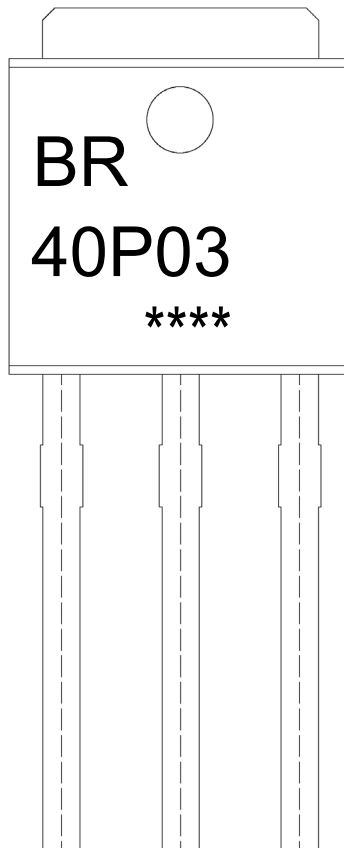

说明：

BR： 为公司代码

40P03： 为型号代码

****： 为生产批号代码，随生产批号变化

Note:

BR: Company Code

40P03: Product Type Code

****: Lot No. Code, code change with Lot No

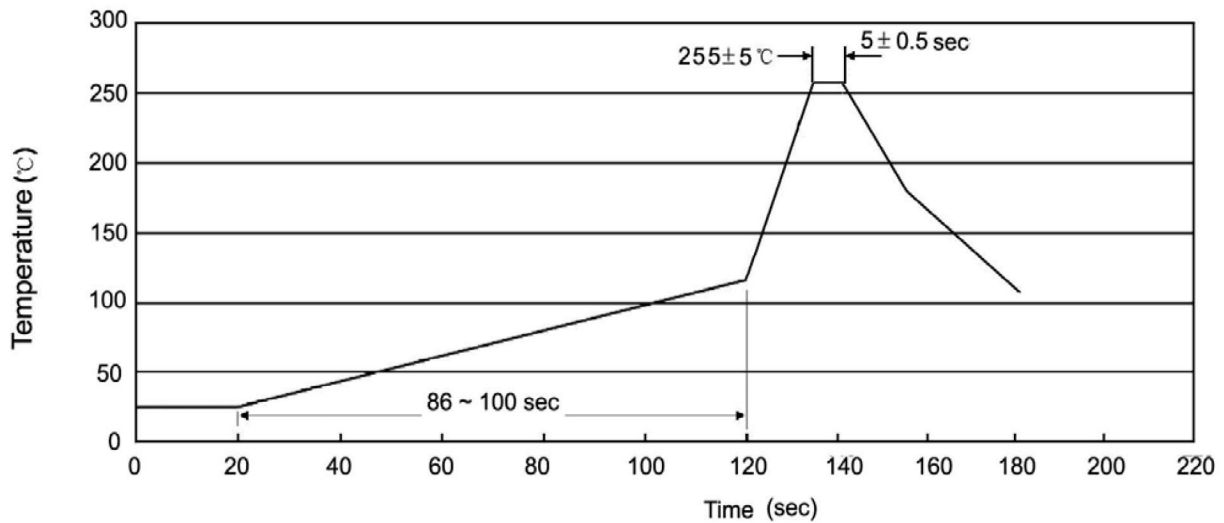
波峰焊温度曲线图(无铅) / Temperature Profile for Dip Soldering(Pb-Free)

说明：

- 1、预热温度 25~150°C，时间 60~90sec；
- 2、峰值温度 255±5°C，时间持续为 5±0.5sec；
- 3、焊接制程冷却速度为 2~10°C/sec.

Note:

- 1.Preheating:25~150°C, Time:60~90sec.
- 2.Peak Temp.:255±5°C, Duration:5±0.5sec.
3. Cooling Speed: 2~10°C/sec.

耐焊接热试验条件 / Resistance to Soldering Heat Test Conditions

温度：270±5°C

时间：10±1 sec.

Temp.:270±5°C

Time:10±1 sec

包装规格 / Packaging SPEC.

散件包装 / BULK

Package Type 封装形式	Units 包装数量					Dimension 包装尺寸 (unit: mm ³)		
	Units/Bag 只/袋	Bags/Inner Box 袋/盒	Units/Inner Box 只/盒	Inner Boxes/Outer Box 盒/箱	Units/Outer Box 只/箱	Bag 袋	Inner Box 盒	Outer Box 箱
TO-251	1,000	10	10,000	5	50,000	135×190	237×172×102	560×245×195

套管包装 / TUBE

Package Type 封装形式	Units 包装数量					Dimension 包装尺寸 (unit: mm ³)		
	Units/Tube 只/套管	Tubes/Inner Box 套管/盒	Units/Inner Box 只/盒	Inner Boxes/Outer Box 盒/箱	Units/Outer Box 只/箱	Tube 套管	Inner Box 盒	Outer Box 箱
TO-251/252	75	48	3,600	5	18,000	526×20.5×5.25	555×164×50	575×290×180

使用说明 / Notices