

BRD4N65

Rev.1 Mar.-2023

描述 / Descriptions

TO-252 塑封封装 N 沟道 MOS 场效应管。N-CHANNEL MOSFET in a TO-252 Plastic Package.

特征 / Features

低栅电荷,低反馈电容,开关速度快,无卤产品。

Low gate charge, low crss, fast switching, HF Product.

用途 / Applications

该器件适用于适配器和充电器的功率开关电路

These devices are well suited for power switch circuit of adaptor and charger.

内部等效电路 / Equivalent Circuit

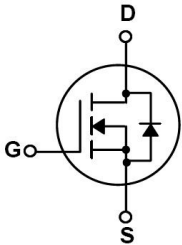

引脚排列 / Pinning

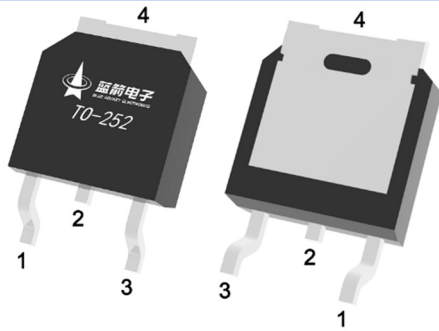

PIN 1 : G

PIN 2 : D

PIN 3 : S

PIN 4 : D

印章代码 / Marking

见印章说明。 See Marking Instructions.

极限参数 / Absolute Maximum Ratings(Ta=25°C)

参数 Parameter	符号 Symbol	数值 Rating	单位 Unit
Drain-Source Voltage	V _{DSS}	650	V
Drain Current	I _D (Tc=25°C)	4.0	A
Drain Current	I _D (Tc=100°C)	3.2	A
Drain Current - Pulsed	I _{DM}	16	A
Gate-Source Voltage	V _{GSS}	±30	V
Single Pulsed Avalanche Energy	E _{AS}	150	mJ
Repetitive Avalanche Energy	E _{AR}	30	mJ
Avalanche Current	I _{AR}	2.5	A
Power Dissipation	P _D (Tc=25°C)	75	W
Operating and Storage Temperature Range	T _J , T _{STG}	-55 to 150	°C

电性能参数 / Electrical Characteristics(Ta=25°C)

参数 Parameter	符号 Symbol	测试条件 Test Conditions	最小值 Min	典型值 Typ	最大值 Max	单位 Unit
Drain-Source Breakdown Voltage	BV _{DSS}	V _{GS} =0V I _D =250μA	650			V
Zero Gate Voltage Drain Current	I _{DSS}	V _{DS} =650V V _{GS} =0V			1	μA
		V _{DS} =520V T _C =125°C			100	μA
Gate-Body Leakage Current Forward	I _{GSS}	V _{GS} =±30V V _{DS} =0V			±100	nA
Gate Threshold Voltage	V _{GS(th)}	V _{DS} =V _{GS} I _D =250μA	2.0		4.0	V
Static Drain-Source On-Resistance	R _{DS(on)}	V _{GS} =10V I _D =2.0A		2.4	2.7	Ω
Forward Transconductance	g _{FS}	V _{DS} =15V I _D =2.0A		3.5		S
Drain-Source Diode Forward Voltage	V _{SD}	V _{GS} =0V I _S =4.0A			1.5	V
Input Capacitance	C _{iSS}	V _{DS} =25V V _{GS} =0V f=1.0MHz		560		pF
Output Capacitance	C _{oss}			50		pF
Reverse Transfer Capacitance	C _{rSS}			2.2		pF
Turn-On Delay Time	t _{d(on)}	V _{DD} =325V I _D =4.0A R _G =10Ω		14		ns
Turn-On Rise Time	t _r			22		ns
Turn-Off Delay Time	t _{d(off)}			29		ns
Turn-Off Fall Time	t _f			15		ns

电参数曲线图 / Electrical Characteristic Curve

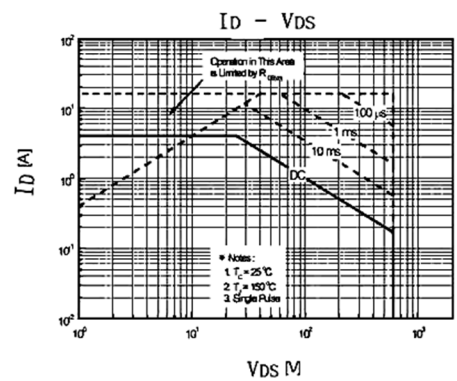
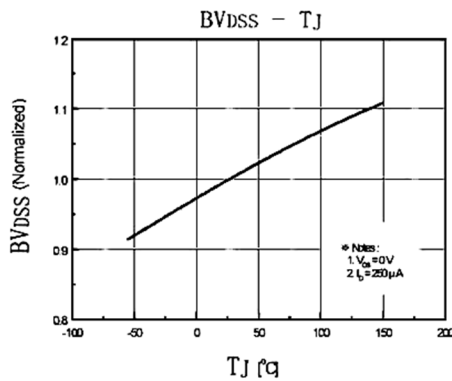
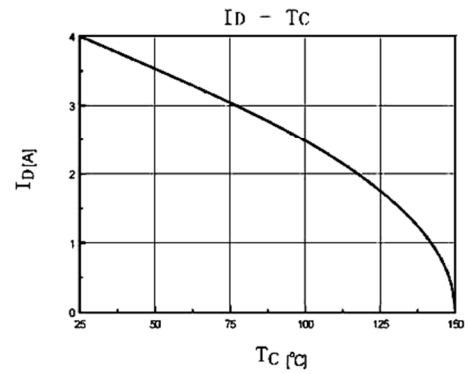
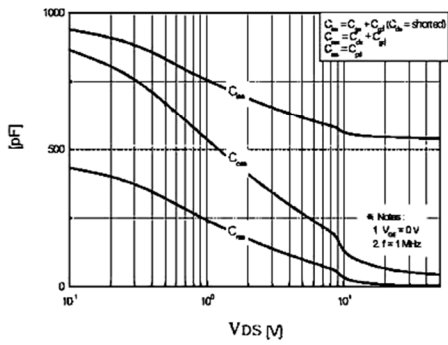
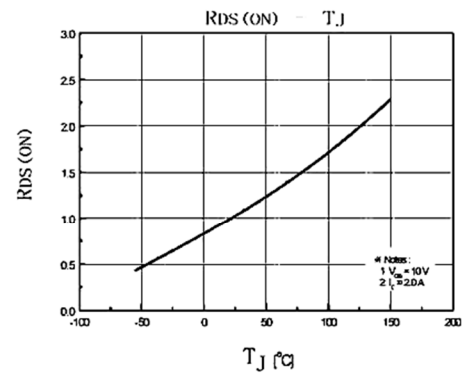
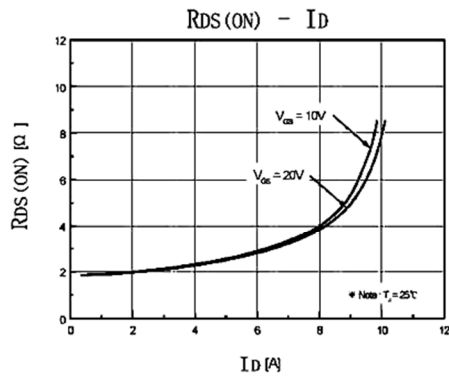
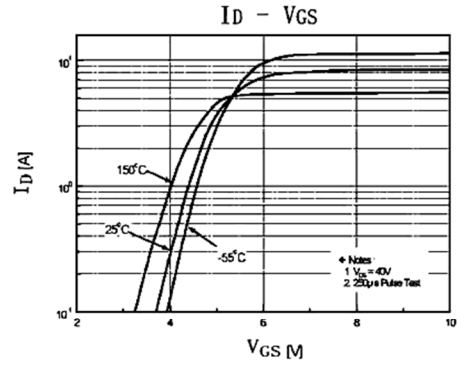
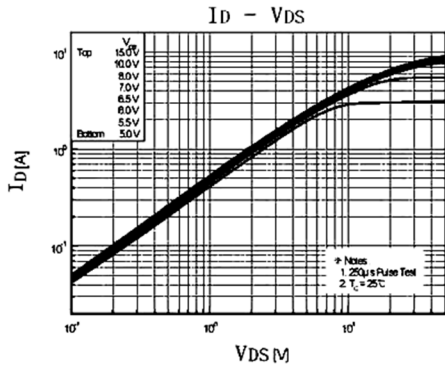

外形尺寸图 / Package Dimensions

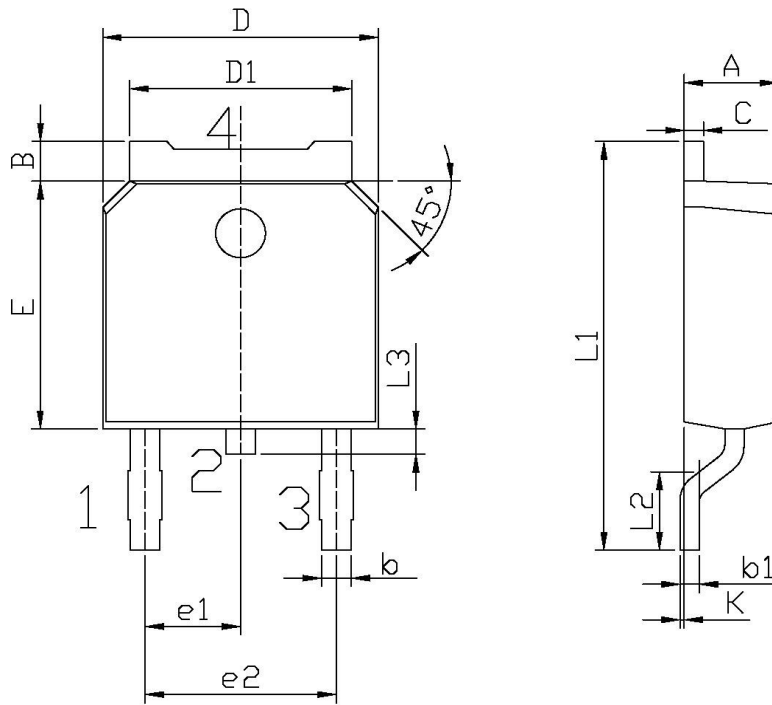

单位: mm

Symbol	Dimensions In Millimeters		Symbol	Dimensions In Millimeters	
	Min	Max		Min	Max
A	2.20	2.40	E	5.95	6.25
B	0.95	1.25	e1	2.24	2.34
b	0.70	0.90	e2	4.43	4.73
b1	0.45	0.55	L1	9.85	10.35
C	0.45	0.55	L2	1.70	2.00
D	6.45	6.75	L3	0.60	0.90
D1	5.10	5.50	K	0.00	0.10

TO-252

印章说明 / Marking Instructions

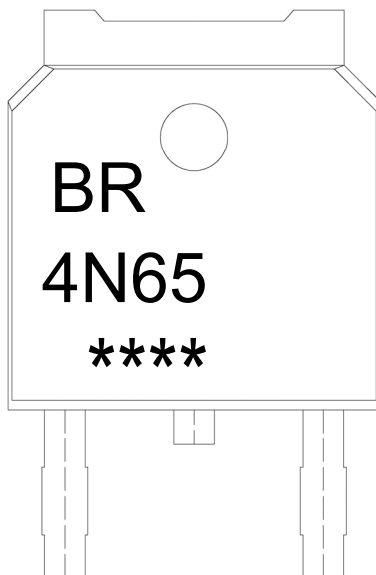

说明：

BR： 为公司代码

4N65： 为型号代码

****： 为生产批号代码，随生产批号变化

Note:

BR: Company Code

4N65: Product Type

****: Lot No. Code, code change with Lot No

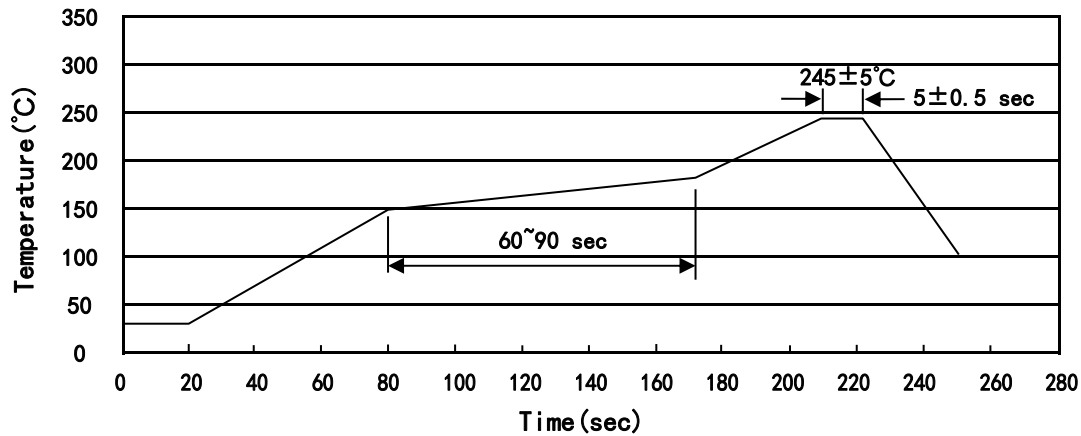
回流焊温度曲线图(无铅) / Temperature Profile for IR Reflow Soldering(Pb-Free)

说明：

- 1、预热温度 150~180°C，时间 60~90sec;
- 2、峰值温度 245±5°C，时间持续为 5±0.5sec;
- 3、焊接制程冷却速度为 2~10°C/sec.

Note:

- 1.Preheating:150~180°C, Time:60~90sec.
- 2.Peak Temp.:245±5°C, Duration:5±0.5sec.
3. Cooling Speed: 2~10°C/sec.

耐焊接热试验条件 / Resistance to Soldering Heat Test Conditions

温度：260±5°C

时间：10±1 sec.

Temp.:260±5°C

Time:10±1 sec

包装规格 / Packaging SPEC.

卷盘包装 / REEL

Package Type 封装形式	Units 包装数量					Dimension 包装尺寸 (unit: mm ³)		
	Units/Reel 只/卷盘	Reels/Inner Box 卷盘/盒	Units/Inner Box 只/盒	Inner Boxes/Outer Box 盒/箱	Units/Outer Box 只/箱	Reel	Inner Box 盒	Outer Box 箱
TO-252	2,500	2	5,000	6	30,000	13" ×16	360×360×50	380×335×366

套管包装 / TUBE

Package Type 封装形式	Units 包装数量					Dimension 包装尺寸 (unit: mm ³)		
	Units/Tube 只/套管	Tubes/Inner Box 套管/盒	Units/Inner Box 只/盒	Inner Boxes/Outer Box 盒/箱	Units/Outer Box 只/箱	Tube 套管	Inner Box 盒	Outer Box 箱
TO-251/252	75	48	3,600	5	18,000	526×20.5×5.25	555×164×50	575×290×180

使用说明 / Notices