

# BRFL65R380C

Rev.A Jul.-2023

## 描述 / Descriptions

TO-220FL 塑封封装 N 沟道 650V 超结工艺功率场效应管。

N-CHANNEL 650V Super-Junction Power MOSFET in a TO-220FL Plastic Package.

## 特征 / Features

低  $R_{DS(on)} \times Q_g$  , 100%雪崩测试, 符合 ROHS 标准。

Very low  $R_{DS(on)} \times Q_g$ , 100% avalanche tested, RoHS compliant.

## 用途 / Applications

用于开关电源, 不间断电源, 功率因素校正。

For switch mode power supply, uninterruptible power supply, power factor correction.

## 内部等效电路 / Equivalent Circuit

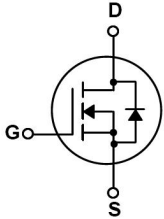

## 引脚排列 / Pinning

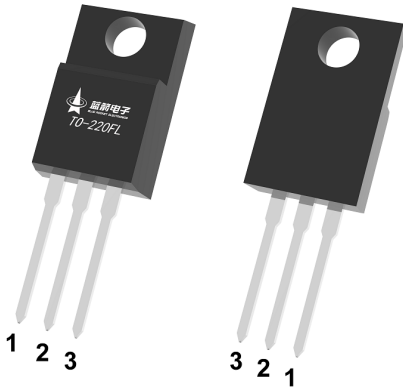

PIN1 : G

PIN 2 : D

PIN 3 : S

## 印章代码 / Marking

见印章说明。 See Marking Instructions.

**极限参数 / Absolute Maximum Ratings(Ta=25°C)**

参数 Parameter	符号 Symbol	数值 Rating	单位 Unit
Drain-Source Voltage	V <sub>DSS</sub>	650	V
Drain Current	I <sub>D</sub> (Tc=25°C)	11	A
Drain Current - Pulsed	I <sub>DM</sub>	44	A
Gate-Source Voltage	V <sub>GS</sub>	±30	V
Single Pulsed Avalanche Energy	E <sub>AS</sub>	277	mJ
Avalanche Current	I <sub>AS</sub>	8	A
Power Dissipation	P <sub>D</sub> (Tc=25°C)	27	W
Operating and Storage Temperature Range	T <sub>J</sub> , T <sub>STG</sub>	-55 to 150	°C
Junction-to-Case	R <sub>θJC</sub>	4.6	°C/W
Junction-to-Ambient	R <sub>θJA</sub>	65	°C/W

**电性能参数 / Electrical Characteristics(Ta=25°C)**

参数 Parameter	符号 Symbol	测试条件 Test Conditions	最小值 Min	典型值 Typ	最大值 Max	单位 Unit
Drain-Source Breakdown Voltage	BV <sub>DSS</sub>	V <sub>GS</sub> =0V I <sub>D</sub> =250μA	650	700		V
Zero Gate Voltage Drain Current	I <sub>DSS</sub>	V <sub>DS</sub> =650V V <sub>GS</sub> =0V T <sub>J</sub> =25°C			1.0	μA
Gate-Body Leakage Current, Forward	I <sub>GSS</sub>	V <sub>GS</sub> =±30V			±100	nA
Gate Threshold Voltage	V <sub>GS(th)</sub>	V <sub>DS</sub> =V <sub>GS</sub> I <sub>D</sub> =250μA	2.5	3.3	4.0	V
Static Drain-Source On-Resistance	R <sub>DSON</sub>	V <sub>GS</sub> =10V I <sub>D</sub> =5.5A		320	380	mΩ
Drain-Source Diode Forward Voltage	V <sub>SD</sub>	V <sub>GS</sub> =0V I <sub>SD</sub> =1A T <sub>J</sub> =25°C			1.2	V
Gate Resistance	R <sub>g</sub>	V <sub>GS</sub> = 0V f = 1.0MHz		4.1		Ω
Input Capacitance	C <sub>iss</sub>	V <sub>DS</sub> =100V V <sub>GS</sub> =0V f=1.0MHz		735		pF
Output Capacitance	C <sub>oss</sub>			35		pF
Reverse Transfer Capacitance	C <sub>rss</sub>			0.45		pF
Turn-On Delay Time	t <sub>d(on)</sub>	V <sub>DS</sub> =400V I <sub>D</sub> =5.5A R <sub>G</sub> =25Ω V <sub>GS</sub> =10V		16.3		ns
Turn-On Rise Time	t <sub>r</sub>			35		ns
Turn-Off Delay Time	t <sub>d(off)</sub>			78		ns
Turn-Off Fall Time	t <sub>f</sub>			39.5		ns

## 电性能参数 / Electrical Characteristics(Ta=25°C)

参数 Parameter	符号 Symbol	测试条件 Test Conditions	最小值 Min	典型值 Typ	最大值 Max	单位 Unit
Continuous Diode Forward Current	I <sub>s</sub>				11	A
Total Gate Charge	Q <sub>g</sub>	V <sub>DS</sub> =480V I <sub>D</sub> =5.5A V <sub>GS</sub> =10V		19.2		nC
Gate-Source Charge	Q <sub>gs</sub>			3.1		nC
Gate-Drain Charge	Q <sub>gd</sub>			8.2		nC
Reverse recovery time	T <sub>rr</sub>	V <sub>R</sub> =400 V, I <sub>F</sub> =5.5A, dI <sub>F</sub> /dt=100 A/μs		310		ns
Reverse recovery charge	Q <sub>rr</sub>			2.8		uC

电参数曲线图 / Electrical Characteristic Curve

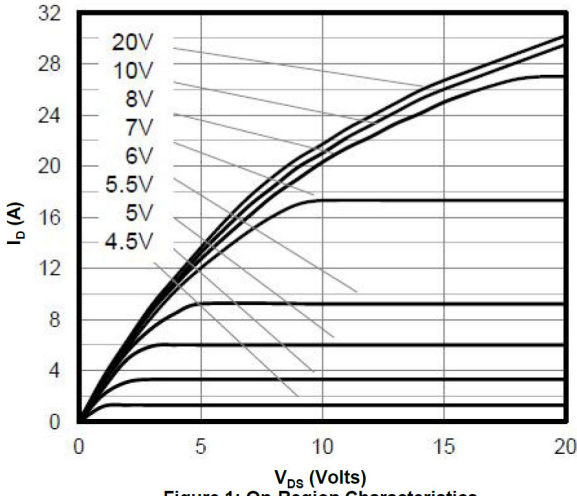

Figure 1: On-Region Characteristics

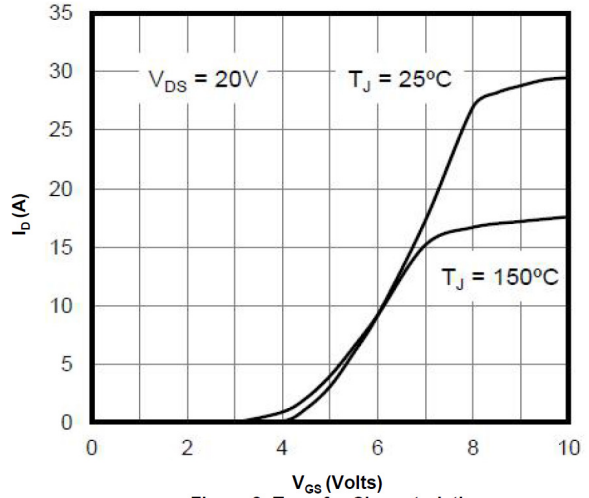

Figure 2: Transfer Characteristics

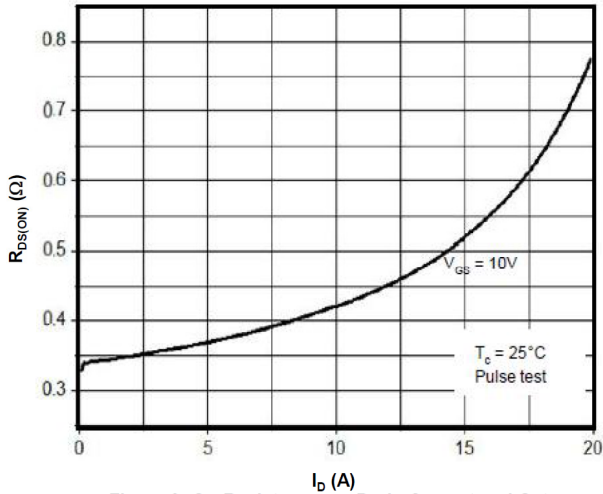

Figure 3: On-Resistance vs. Drain Current and Gate Voltage

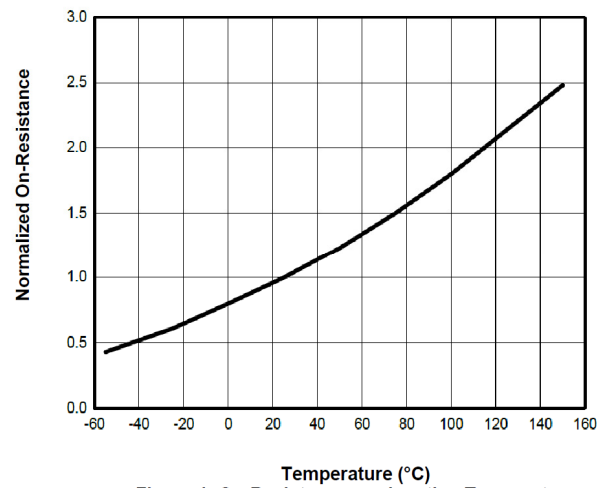

Figure 4: On-Resistance vs. Junction Temperature

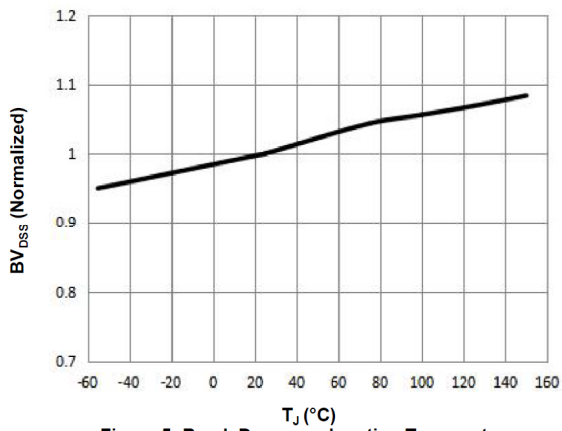

Figure 5: Break Down vs. Junction Temperature

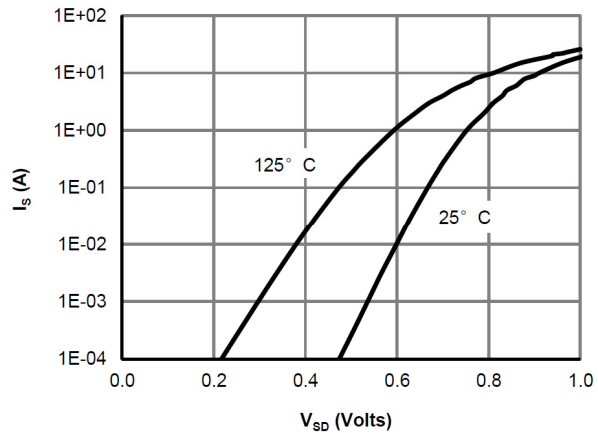

Figure 6: Body-Diode Characteristics

## 电参数曲线图 / Electrical Characteristic Curve

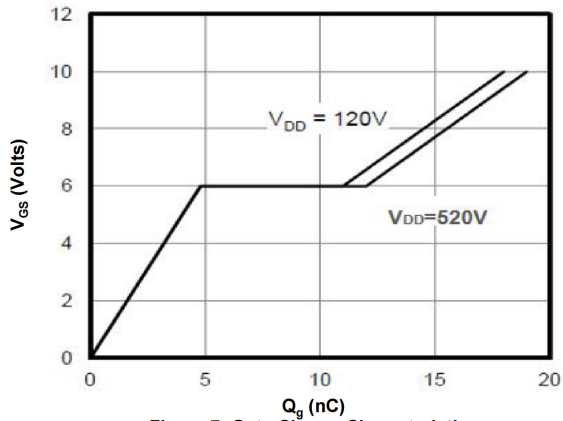

Figure 7: Gate-Charge Characteristics

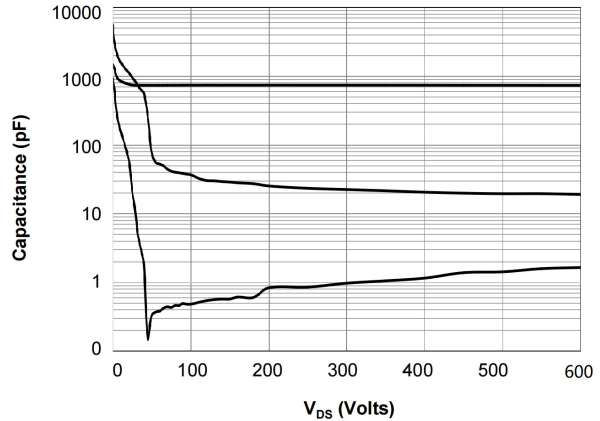

Figure 8: Capacitance Characteristics

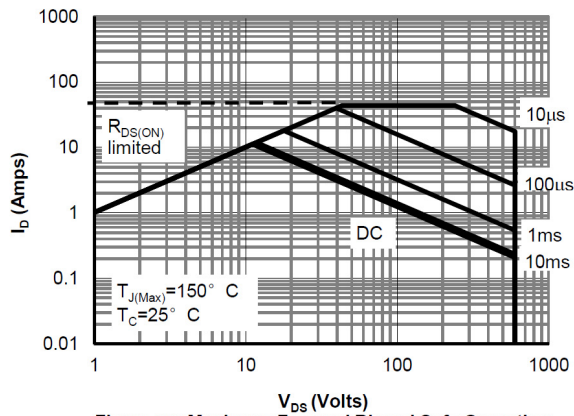

Figure 09: Maximum Forward Biased Safe Operating Area

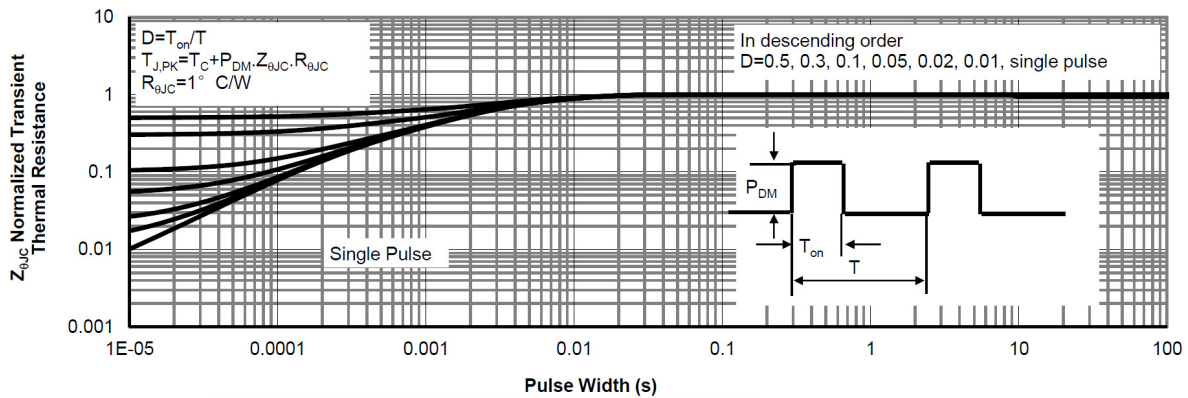
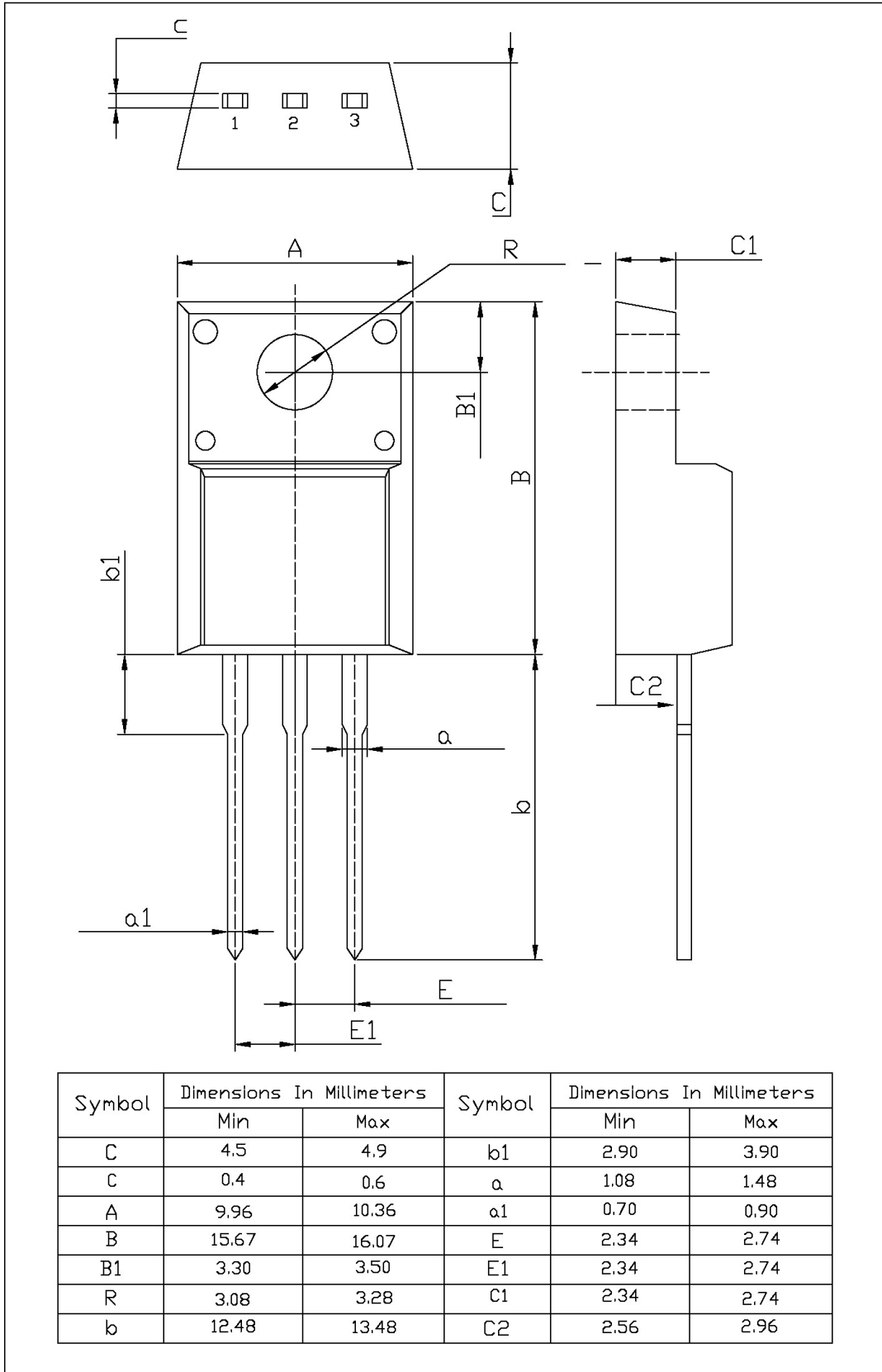

Figure 10: Normalized Maximum Transient Thermal Impedance

外形尺寸图 / Package Dimensions

TO-220FL

单位: mm



**印章说明 / Marking Instructions**

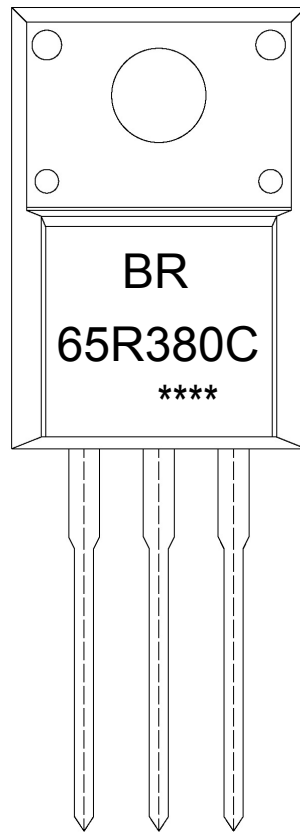

说明：

BR： 为公司代码

65R380C： 为型号代码

\*\*\*\*： 为生产批号代码，随生产批号变化

Note:

BR: Company Code

65R380C: Product Type

\*\*\*\*: Lot No. Code, code change with Lot No

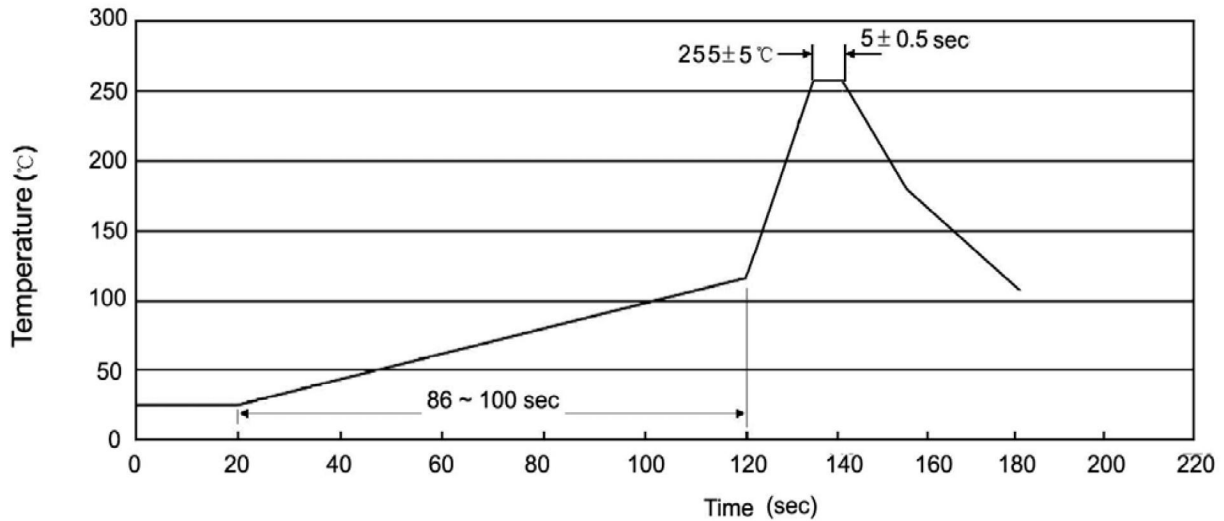
**波峰焊温度曲线图(无铅) / Temperature Profile for Dip Soldering(Pb-Free)**

说明：

- 1、预热温度 25 ~ 150°C，时间 60 ~ 90sec；
- 2、峰值温度 255±5°C，时间持续为 5±0.5sec；
- 3、焊接制程冷却速度为 2 ~ 10°C/sec.

Note:

- 1.Preheating:25~150°C, Time:60~90sec.
- 2.Peak Temp.:255±5°C, Duration:5±0.5sec.
3. Cooling Speed: 2~10°C/sec.

**耐焊接热试验条件 / Resistance to Soldering Heat Test Conditions**

温度：270±5°C

时间：10±1 sec.

Temp.:270±5°C

Time:10±1 sec

**包装规格 / Packaging SPEC.**

套管包装 / TUBE

Package Type 封装形式	Units 包装数量					Dimension 包装尺寸 (unit: mm <sup>3</sup> )		
	Units/Tube 只/套管	Tubes/Inner Box 套管/盒	Units/Inner Box 只/盒	Inner Boxes/Outer Box 盒/箱	Units/Outer Box 只/箱	Tube 套管	Inner Box 盒	Outer Box 箱
TO-220FL	50	20	1,000	5	5,000	532×33×7.0	555×164×50	575×290×180

**使用说明 / Notices**