

BRFL65R380T

Rev.A Apr.-2025

描述 / Descriptions

TO-220FL 塑封封装 N 沟道 650V 超结工艺功率场效应管。

N-CHANNEL 650V Super-Junction Power MOSFET in a TO-220FL Plastic Package.

特征 / Features

低 $R_{DS(on)} \times Q_g$, 100%雪崩测试, 符合 ROHS 标准。

Very low $R_{DS(on)} \times Q_g$, 100% avalanche tested, RoHS compliant.

用途 / Applications

用于开关电源, 不间断电源, 功率因素校正。

For switch mode power supply, uninterruptible power supply, power factor correction.

内部等效电路 / Equivalent Circuit

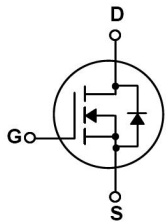

引脚排列 / Pinning

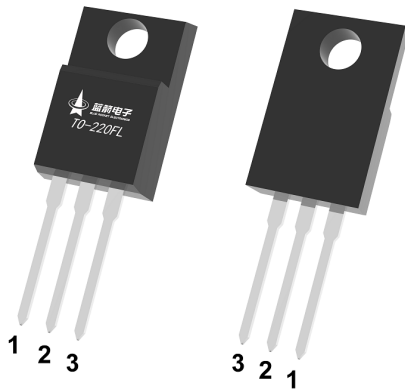

PIN1 : G

PIN 2 : D

PIN 3 : S

印章代码 / Marking

见印章说明。

See Marking Instructions.

极限参数 / Absolute Maximum Ratings(Ta=25°C)

参数 Parameter	符号 Symbol	数值 Rating	单位 Unit
Drain-Source Voltage	V_{DS}	650	V
Drain Current	$I_D(T_c=25^\circ\text{C})$	11	A
Drain Current - Pulsed	I_{DM}	44	A
Gate-Source Voltage	V_{GS}	± 30	V
Single Pulsed Avalanche Energy	E_{AS}	243	mJ
Avalanche Current	I_{AS}	7.5	A
Power Dissipation	$P_D(T_c=25^\circ\text{C})$	27	W
Operating and Storage Temperature Range	T_J, T_{STG}	-55 to 150	$^\circ\text{C}$
Junction-to-Case	$R_{\theta JC}$	4.6	$^\circ\text{C/W}$
Junction-to-Ambient	$R_{\theta JA}$	65	$^\circ\text{C/W}$

电性能参数 / Electrical Characteristics(Ta=25°C)

参数 Parameter	符号 Symbol	测试条件 Test Conditions	最小值 Min	典型值 Typ	最大值 Max	单位 Unit
Drain-Source Breakdown Voltage	BV_{DSS}	$V_{GS}=0V$ $I_D=250\mu A$	650			V
Zero Gate Voltage Drain Current	I_{DSS}	$V_{DS}=650V$ $V_{GS}=0V$ $T_J=25^\circ\text{C}$			1.0	μA
Gate-Body Leakage Current, Forward	I_{GSS}	$V_{GS}=\pm 30V$			± 100	nA
Gate Threshold Voltage	$V_{GS(th)}$	$V_{DS}=V_{GS}$ $I_D=250\mu A$	2.5	3.3	4.0	V
Static Drain-Source On-Resistance	$R_{DS(on)}$	$V_{GS}=10V$ $I_D=5.5A$		370	380	m Ω
Drain-Source Diode Forward Voltage	V_{SD}	$V_{GS}=0V$ $I_{SD}=1A$ $T_J=25^\circ\text{C}$			1.2	V
Gate Resistance	R_g	$V_{GS}=0V$ $f=1.0\text{MHz}$		9.5		Ω
Input Capacitance	C_{iss}	$V_{DS}=25V$ $V_{GS}=0V$ $f=1.0\text{MHz}$		690		pF
Output Capacitance	C_{oss}			940		pF
Reverse Transfer Capacitance	C_{rss}			11		pF
Turn-On Delay Time	$t_{d(on)}$	$V_{DS}=400V$ $I_D=5.5A$ $R_G=25\Omega$ $V_{GS}=10V$		44.8		ns
Turn-On Rise Time	t_r			19.3		ns
Turn-Off Delay Time	$t_{d(off)}$			68.3		ns
Turn-Off Fall Time	t_f			16.5		ns

电性能参数 / Electrical Characteristics(Ta=25°C)

参数 Parameter	符号 Symbol	测试条件 Test Conditions	最小值 Min	典型值 Typ	最大值 Max	单位 Unit
Continuous Diode Forward Current	I _s				11	A
Total Gate Charge	Q _g	V _{DS} =480V I _D =5.5A V _{GS} =10V		15.8		nC
Gate-Source Charge	Q _{gs}			4.3		nC
Gate-Drain Charge	Q _{gd}			1.7		nC
Reverse recovery time	T _{rr}	V _R =400 V, I _F =5.5A, dI _F /dt=100 A/μs		194.6		ns
Reverse recovery charge	Q _{rr}			1.8		uC

电参数曲线图 / Electrical Characteristic Curve

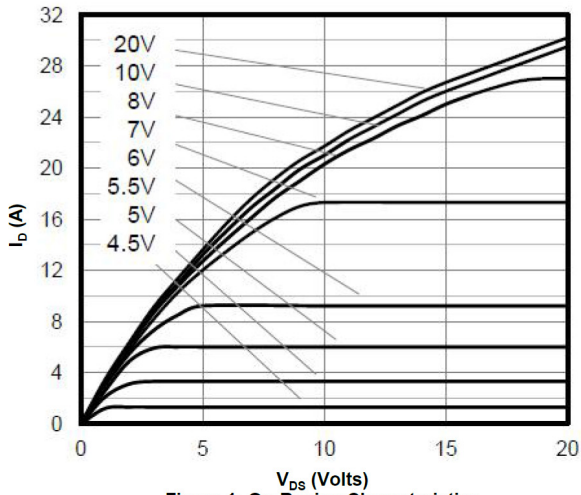

Figure 1: On-Region Characteristics

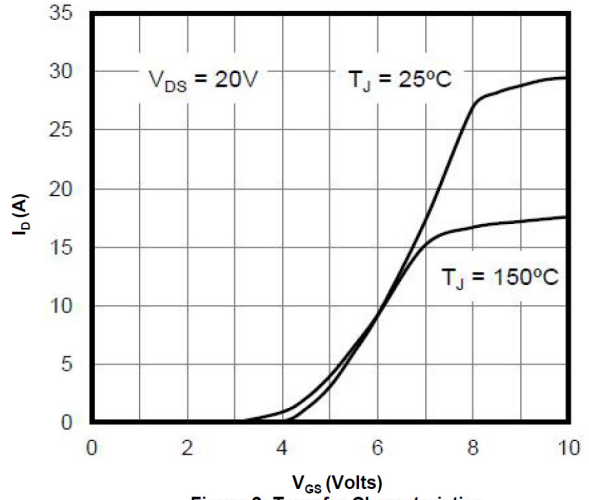

Figure 2: Transfer Characteristics

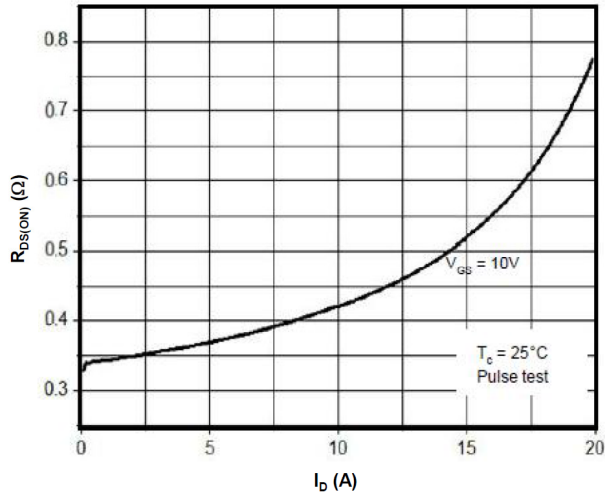

Figure 3: On-Resistance vs. Drain Current and Gate Voltage

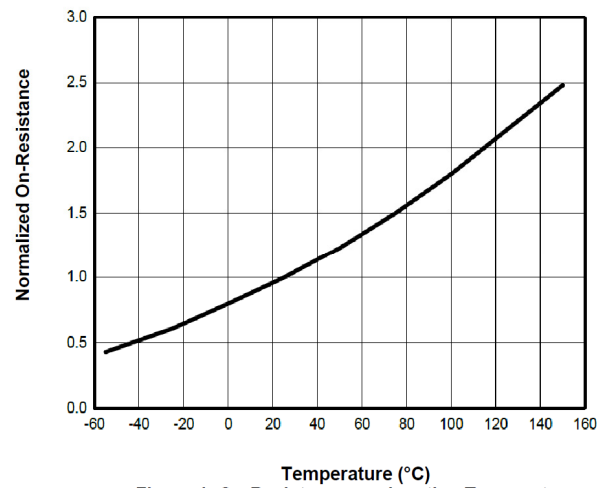

Figure 4: On-Resistance vs. Junction Temperature

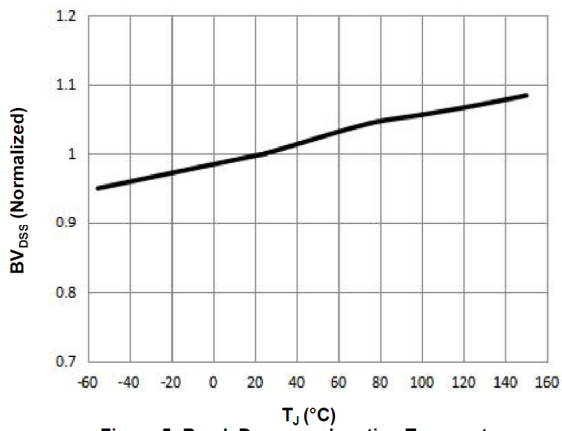

Figure 5: Break Down vs. Junction Temperature

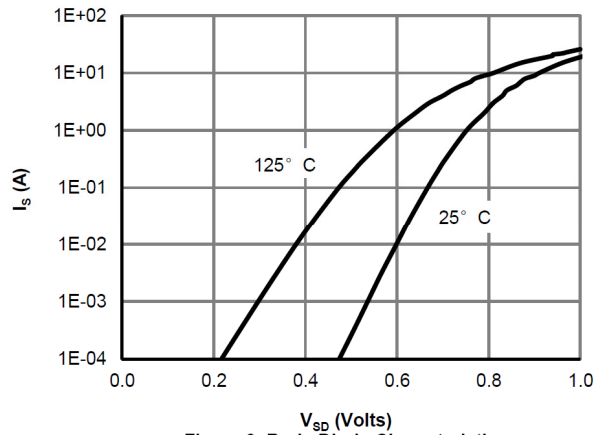

Figure 6: Body-Diode Characteristics

电参数曲线图 / Electrical Characteristic Curve

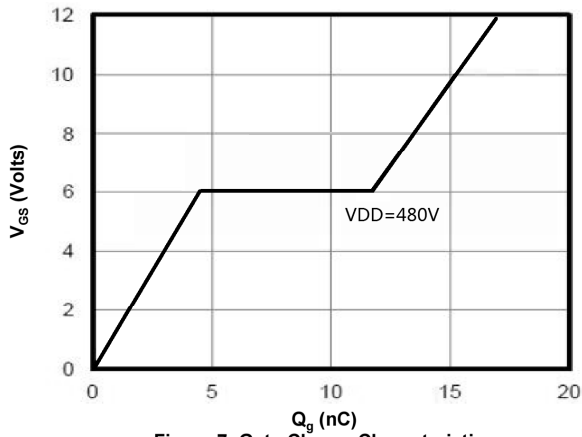

Figure 7: Gate-Charge Characteristics

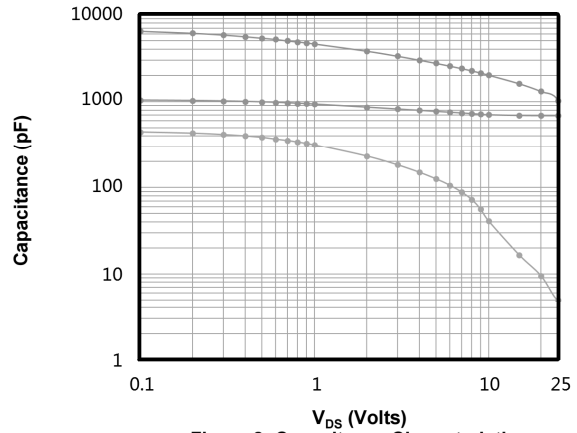

Figure 8: Capacitance Characteristics

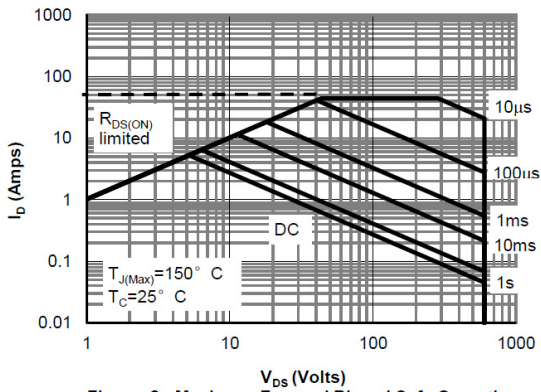

Figure 9 : Maximum Forward Biased Safe Operating Area

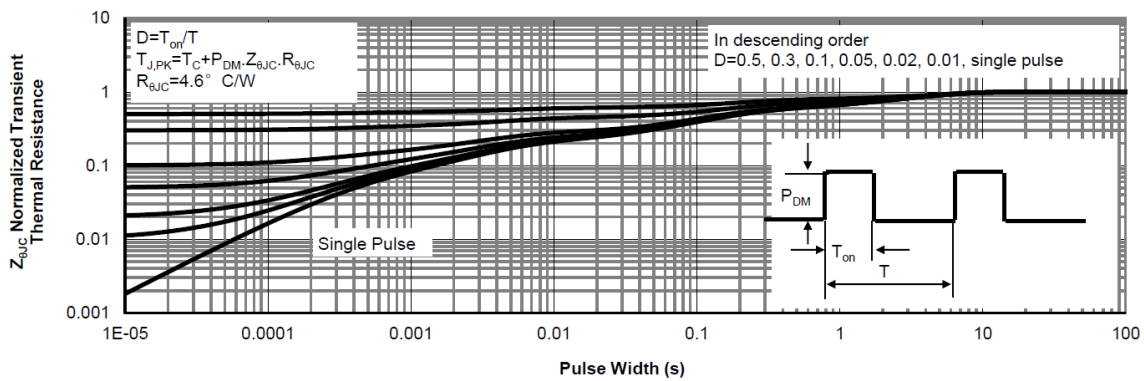
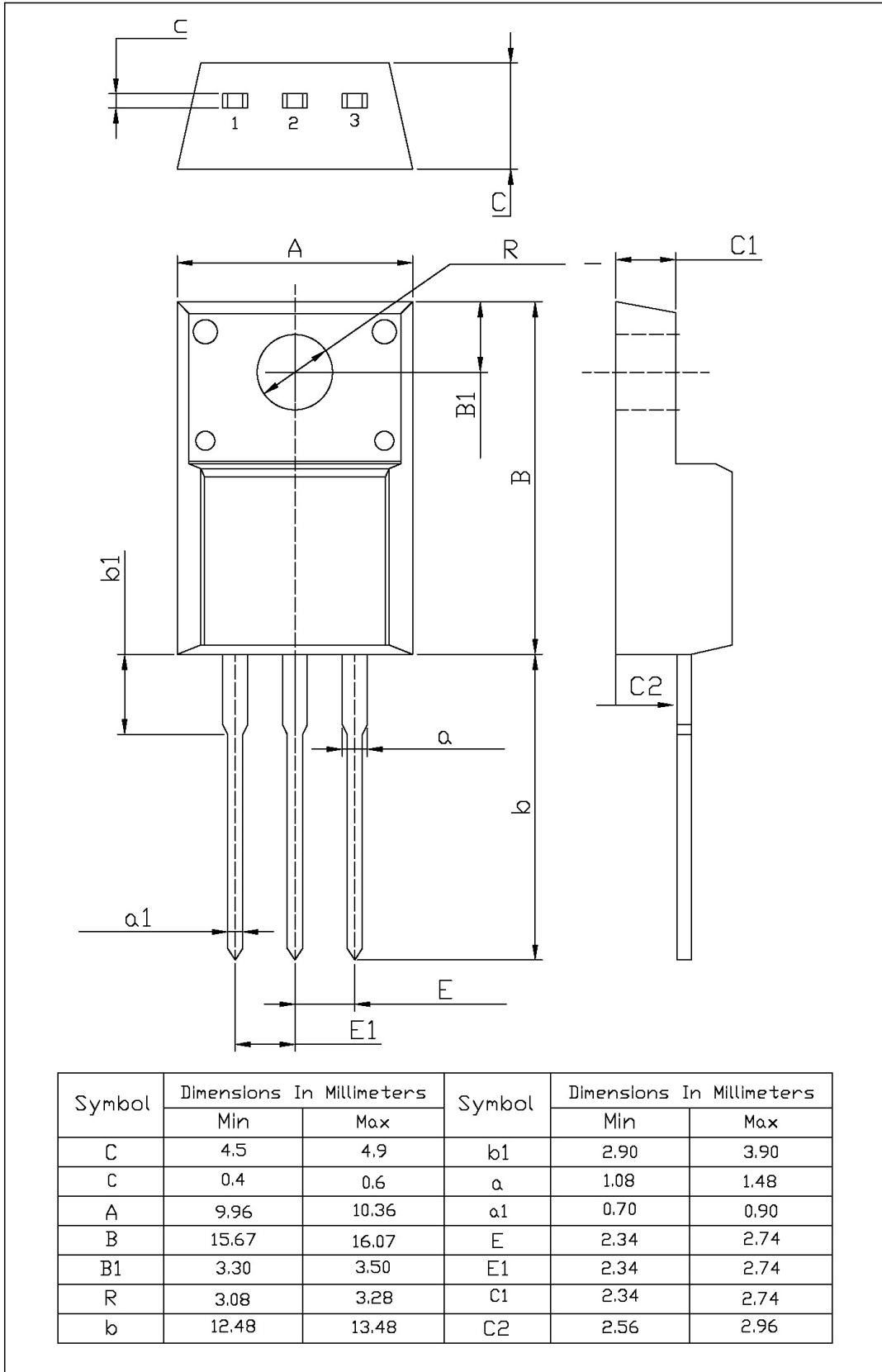

Figure 10: Normalized Maximum Transient Thermal Impedance

外形尺寸图 / Package Dimensions

TO-220FL

单位: mm



印章说明 / Marking Instructions

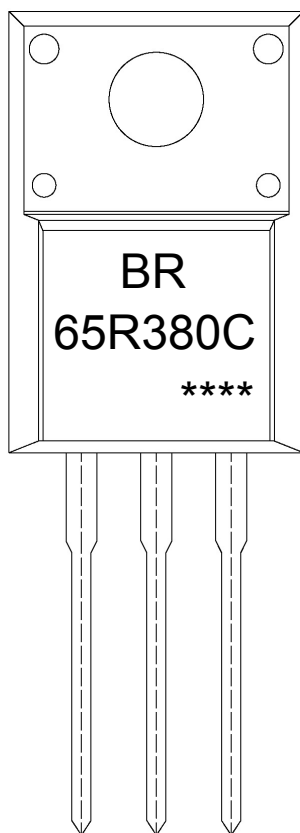

说明：

BR： 为公司代码

65R380C： 为型号代码

****： 为生产批号代码，随生产批号变化

Note:

BR: Company Code

65R380C: Product Type Code

****: Lot No. Code, code change with Lot No

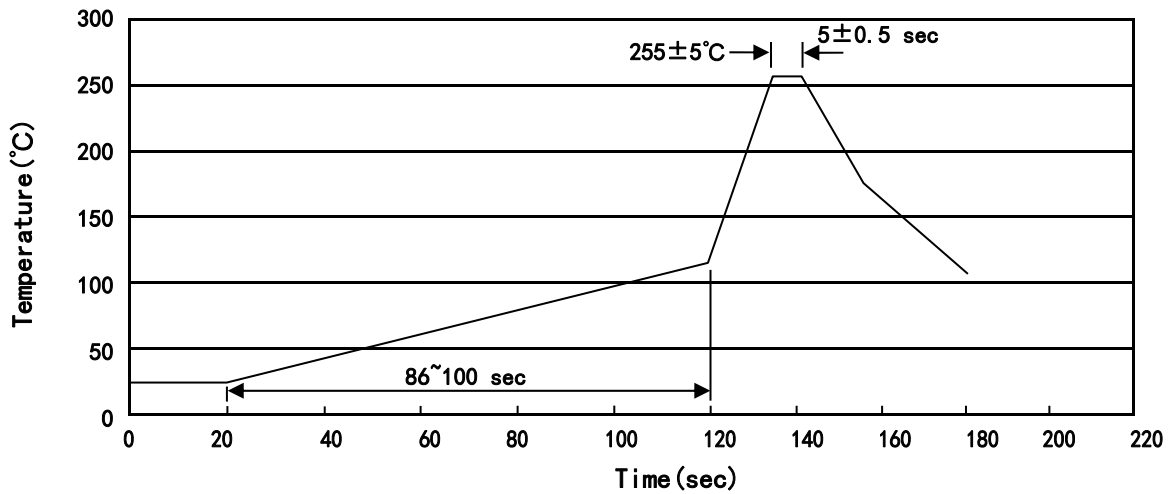
波峰焊温度曲线图(无铅) / Temperature Profile for Dip Soldering(Pb-Free)

说明：

- 1、预热温度 25~150°C，时间 60~90sec;
- 2、峰值温度 255±5°C，时间持续为 5±0.5sec;
- 3、焊接制程冷却速度为 2~10°C/sec.

Note:

- 1.Preheating:25~150°C, Time:60~90sec.
- 2.Peak Temp.:255±5°C, Duration:5±0.5sec.
3. Cooling Speed: 2~10°C/sec.

耐焊接热试验条件 / Resistance to Soldering Heat Test Conditions

温度：270±5°C

时间：10±1 sec.

Temp.:270±5°C

Time:10±1 sec

包装规格 / Packaging SPEC.

套管包装 / TUBE

Package Type 封装形式	Units 包装数量					Dimension 包装尺寸 (unit: mm ³)		
	Units/Tube 只/套管	Tubes/Inner Box 套管/盒	Units/Inner Box 只/盒	Inner Boxes/Outer Box 盒/箱	Units/Outer Box 只/箱	Tube 套管	Inner Box 盒	Outer Box 箱
TO-220FL	50	20	1,000	5	5,000	532×33×7.0	555×164×50	575×290×180

使用说明 / Notices