

MBRD1045

Rev.H Oct.-2024

描述 / Descriptions

TO-252 塑封封装 肖特基二极管。
Schottky Barrier Diode in a TO-252 Plastic Package.

特征 / Features

损耗低，效率高，无卤产品。
Low power loss, high efficiency, HF Product.

用途 / Applications

用于高频、低压、大电流整流二极管，续流二极管，保护二极管。
For use in low voltage, high frequency inverters, free wheeling, and polarity protection applications.

内部等效电路 / Equivalent Circuit

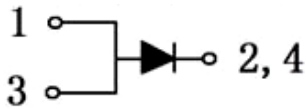

引脚排列 / Pinning

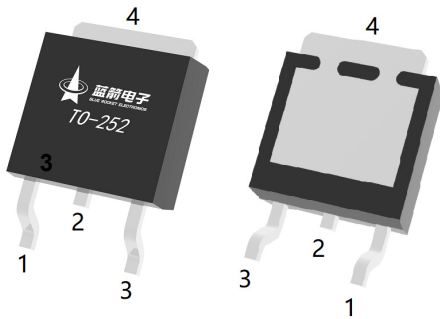

PIN1 : Anode

PIN 2,4 : Cathode

PIN 3 : Anode

印章代码 / Marking

见印章说明。
See Marking Instructions.

极限参数 / Absolute Maximum Ratings(Ta=25°C)

| 参数 Parameter | 符号 Symbol | 数值 Rating | 单位 Unit |
|---|------------------------|--------------|------------|
| Peak Repetitive Reverse Voltage Working Peak Reverse Voltage | V_{RRM} V_{RWM} | 45 | V |
| Reverse Voltage | V_R | 45 | V |
| Average Rectified Forward Current | $I_{F(AV)}$ | 10 | A |
| Non Repetitive Peak Surge Current | I_{FSM} | 100 | A |
| Junction Temperature Range | T_j | 150 | °C |
| Storage Temperature Range | T_{stg} | -65~150 | °C |

电性能参数 / Electrical Characteristics(Ta=25°C)

| 参数 Parameter | 符号 Symbol | 测试条件 Test Conditions | 最小值 Min | 典型值 Typ | 最大值 Max | 单位 Unit |
|-------------------------------|--------------|---------------------------|------------|------------|------------|------------|
| Reverse Voltage | V_R | $I_R = 1mA$ | 45 | | | V |
| Peak Forward Voltage | V_{FM} | $I_F = 2.0A(T_C = 25°C)$ | | 0.41 | 0.45 | V |
| | | $I_F = 2.0A(T_C = 125°C)$ | | 0.37 | 0.41 | V |
| | | $I_F = 10A(T_C = 25°C)$ | | 0.55 | 0.6 | V |
| Instantaneous Reverse Current | I_{RM} | $V_R = 40V(T_C = 25°C)$ | | | 0.5 | mA |
| | | $V_R = 40V(T_C = 125°C)$ | | | 50 | mA |
| Voltage Rate of Change | dv/dt | | | | 10000 | V/μs |

电参数曲线图 / Electrical Characteristic Curve

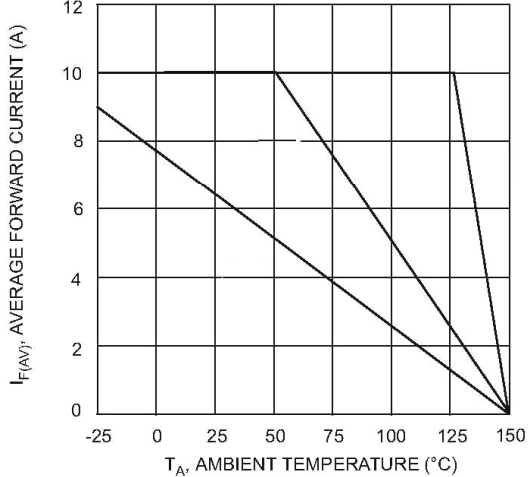
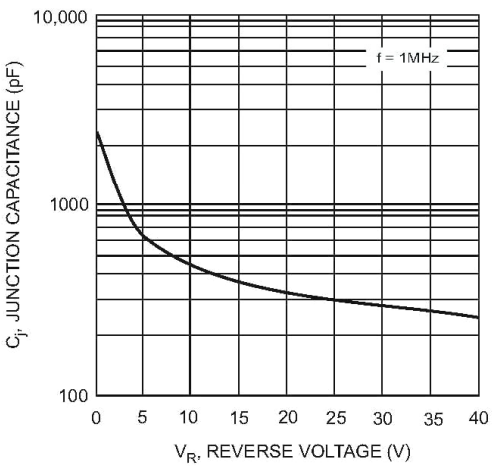
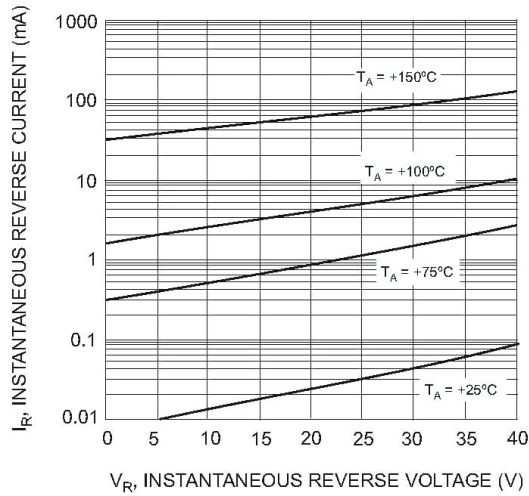
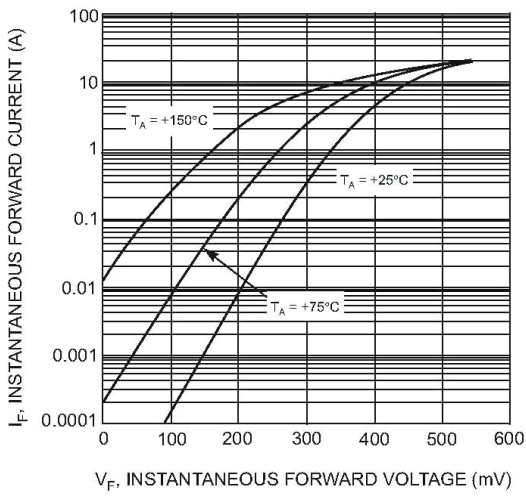

外形尺寸图 / Package Dimensions

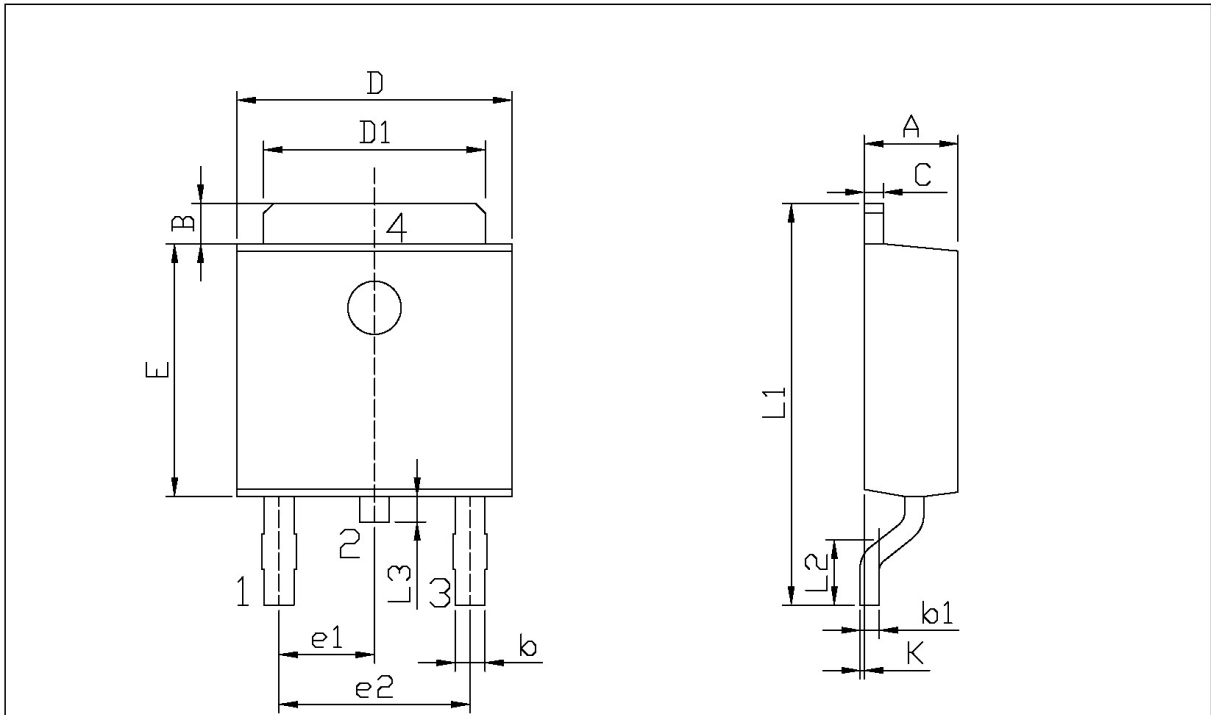

单位: mm

| Symbol | Dimensions In Millimeters | | Symbol | Dimensions In Millimeters | |
|--------|---------------------------|------|--------|---------------------------|------|
| | Min | Max | | Min | Max |
| A | 2.20 | 2.40 | E | 5.95 | 6.25 |
| B | 0.95 | 1.25 | e1 | 2.24 | 2.34 |
| b | 0.50 | 0.90 | e2 | 4.43 | 4.73 |
| b1 | 0.45 | 0.55 | L1 | 9.45 | 9.95 |
| C | 0.45 | 0.55 | L2 | 1.25 | 1.75 |
| D | 6.45 | 6.75 | L3 | 0.60 | 0.90 |
| D1 | 5.10 | 5.50 | K | 0.00 | 0.10 |

TO-252

印章说明 / Marking Instructions

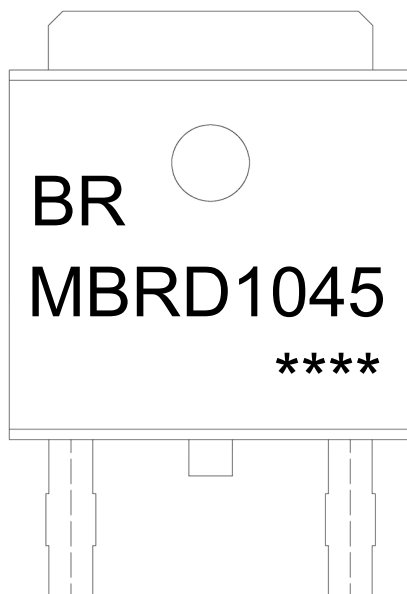

说明：

BR： 为公司代码

MBRD1045： 为型号代码

****： 为生产批号代码，随生产批号变化

Note:

BR: Company Code

MBRD1045: Product Type Code

****: Lot No. Code, code change with Lot No

回流焊温度曲线图(无铅) / Temperature Profile for IR Reflow Soldering(Pb-Free)

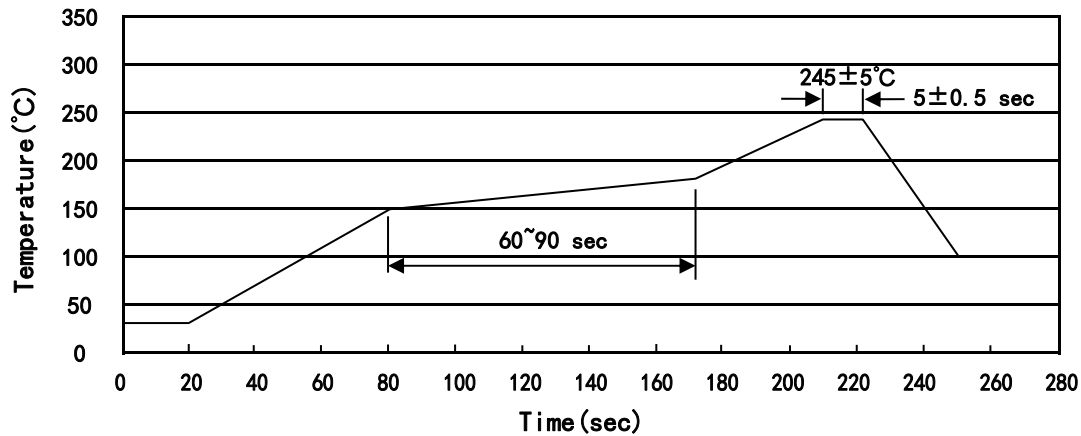

说明：

- 1、预热温度 150~180°C，时间 60~90sec;
- 2、峰值温度 245±5°C，时间持续为 5±0.5sec;
- 3、焊接制程冷却速度为 2~10°C/sec.

Note:

- 1.Preheating:150~180°C, Time:60~90sec.
- 2.Peak Temp.:245±5°C, Duration:5±0.5sec.
3. Cooling Speed: 2~10°C/sec.

耐焊接热试验条件 / Resistance to Soldering Heat Test Conditions

温度：260±5°C 时间：10±1 sec. Temp.:260±5°C Time:10±1 sec

包装规格 / Packaging SPEC.

卷盘包装 / REEL

| Package Type 封装形式 | Units 包装数量 | | | | | Dimension 包装尺寸 (unit: mm ³) | | |
|----------------------|--------------------|-------------------------|------------------------|------------------------------|------------------------|---|-------------|-------------|
| | Units/Reel 只/卷盘 | Reels/Inner Box 卷盘/盒 | Units/Inner Box 只/盒 | Inner Boxes/Outer Box 盒/箱 | Units/Outer Box 只/箱 | Reel | Inner Box 盒 | Outer Box 箱 |
| TO-252 | 2,500 | 2 | 5,000 | 6 | 30,000 | 13" ×16 | 360×360×50 | 380×335×366 |

套管包装 / TUBE

| Package Type 封装形式 | Units 包装数量 | | | | | Dimension 包装尺寸 (unit: mm ³) | | |
|----------------------|--------------------|-------------------------|------------------------|------------------------------|------------------------|---|-------------|-------------|
| | Units/Tube 只/套管 | Tubes/Inner Box 套管/盒 | Units/Inner Box 只/盒 | Inner Boxes/Outer Box 盒/箱 | Units/Outer Box 只/箱 | Tube 套管 | Inner Box 盒 | Outer Box 箱 |
| TO-251/252 | 75 | 48 | 3,600 | 5 | 18,000 | 526×20.5×5.25 | 555×164×50 | 575×290×180 |

使用说明 / Notices