

描述 / Descriptions

表面贴装肖特基整流二极管，反向电压：40V，正向电流：3.0A，薄型 SMAF 封装。
Surface Mount Schottky Barrier Rectifier, Reverse Voltage: 40V, Forward Current: 3.0A ,SMAF thin package.

特征 / Features

低功耗，高效率，正向浪涌电流大，适用于低压高频逆变器和极性保护，表面贴装。无卤产品。
Low power loss, high efficiency, High forward surge current capability, For use in low voltage, high frequency inverters, and polarity protection applications, For surface mounted applications. Halogen free product.

用途 / Applications

一般用途。
General purpose.

内部等效电路 / Equivalent Circuit



引脚排列 / Pinning



PIN	DESCRIPTION
1	Cathode
2	Anode

The recommended mounting pad size

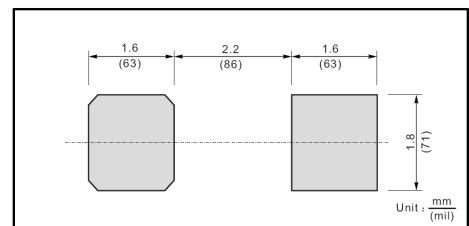

印章代码 / Marking

见印章说明。 See Marking Instructions.

极限参数 / Absolute Maximum Ratings(Ta=25°C)

参数 Parameter	符号 Symbol	数值 Rating	单位 Unit
Maximum Repetitive Peak Reverse Voltage	V_{RRM}	40	V
Maximum RMS voltage	V_{RMS}	28	V
Maximum DC Blocking Voltage	V_{DC}	40	V
Maximum Average Forward Rectified Current	$I_{F(AV)}$	3.0	A
Peak Forward Surge Current,8.3ms Single Half Sine-wave Superimposed on Rated Load (JEDEC method)	I_{FSM}	80	A
Typical Junction Capacitance ¹⁾	C_i	450	pF
Typical Thermal Resistance ²⁾	$R_{\theta JA}$	50	°C/W
Operating Junction Temperature Range	T_j	-55~125	°C
Storage Temperature Range	T_{stg}	-55~150	°C

Note:

- 1) Measured at 1MHz and applied reverse voltage of 4 V D.C.
- 2) P.C.B. mounted with 0.5 X 0.5" (12.7 X 12.7 mm) copper pad areas.

电性能参数 / Electrical Characteristics(Ta=25°C)

参数 Parameter	符号 Symbol	测试条件 Test Conditions	数值 Rating	单位 Unit
Max Instantaneous Forward Voltage	V_F	$I_F=3.0A$	0.45	V
Maximum DC Reverse Current at Rated DC Reverse Voltage	I_R	$T_a=25^\circ C$	0.3	mA
		$T_a=100^\circ C$	5.0	

电参数曲线图 / Electrical Characteristic Curve

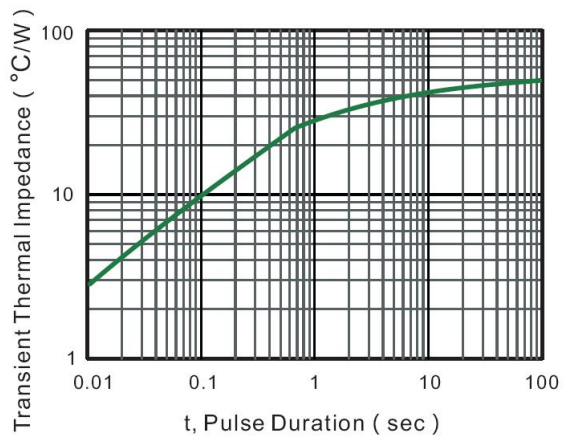
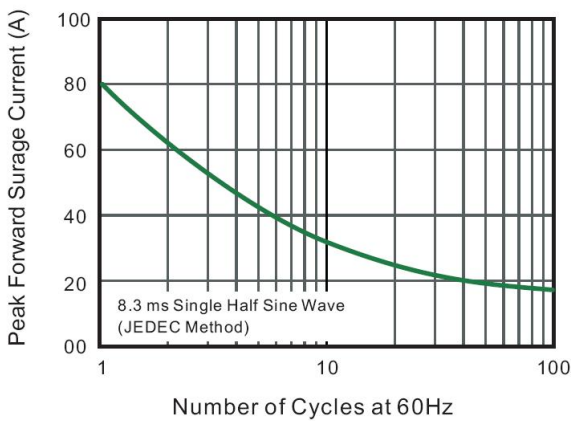
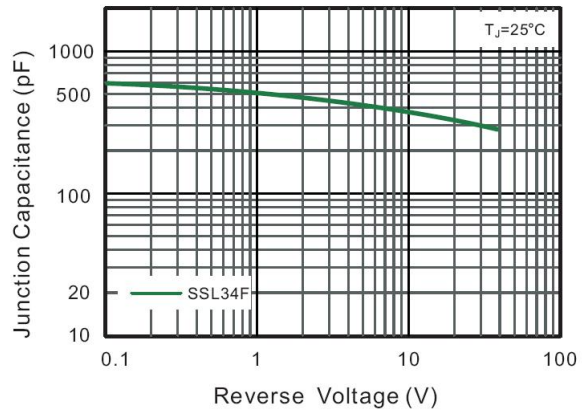
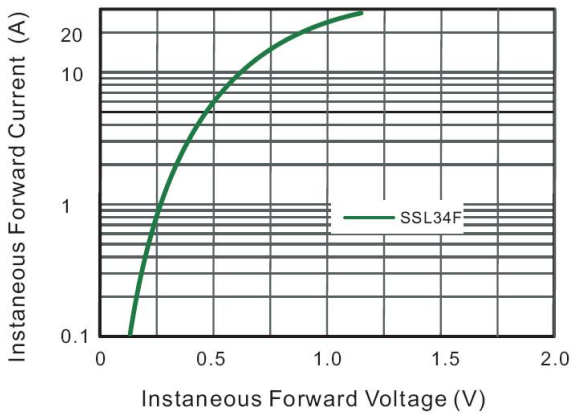
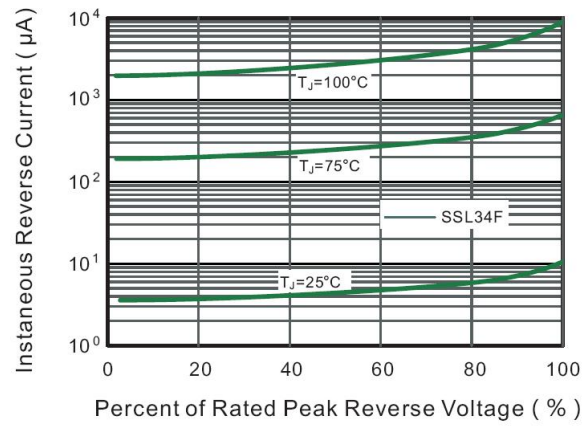
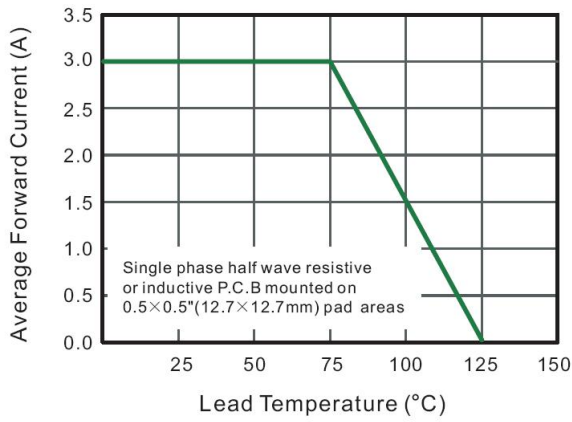

外形尺寸图 / Package Dimensions

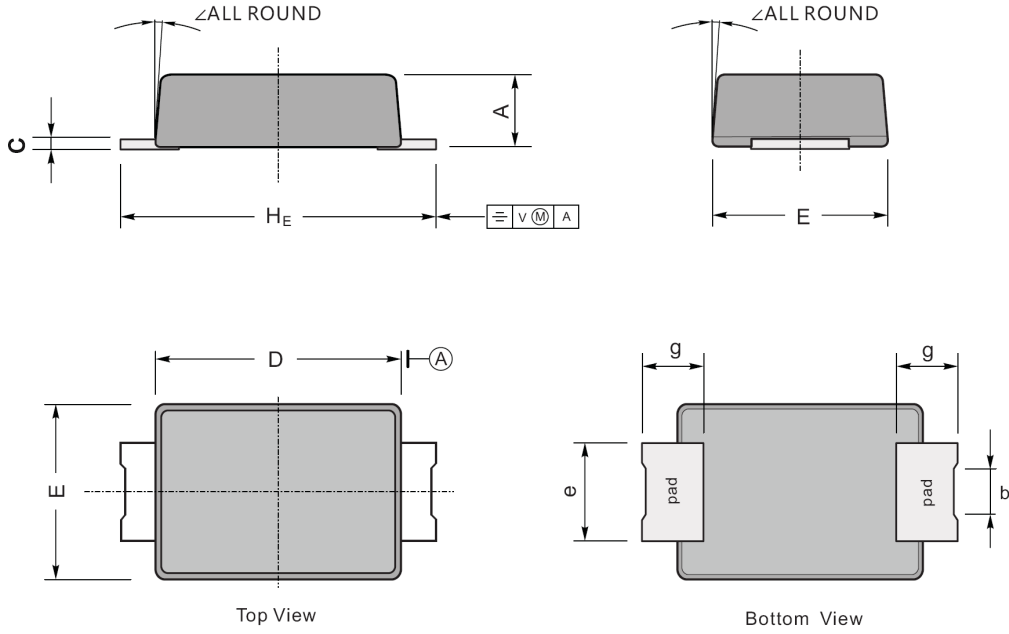

UNIT		A	C	D	E	e	g	H_E	b	\angle
mm	max	1.2	0.20	3.7	2.7	1.6	1.2	4.9	1.05	7°
	min	0.9	0.12	3.3	2.4	1.3	0.8	4.4	0.65	
mil	max	47	7.9	146	106	63	47	193	41	
	min	35	4.7	130	94	51	31	173	26	

Marking

Type number	Marking code
SSL34F	SSL34

印章说明 / Marking Instructions



说明：

SSL34：为型号代码

****：为生产批号追溯码，第1个*为年月代码，后面3个*为当月小批号代码

Note:

SSL34：Product Type Code

****：Lot No. Code ,The 1st * means:YM Code ,The last 3 * means:little Lot No
Code

回流焊温度曲线图(无铅) / Temperature Profile for IR Reflow Soldering(Pb-Free)

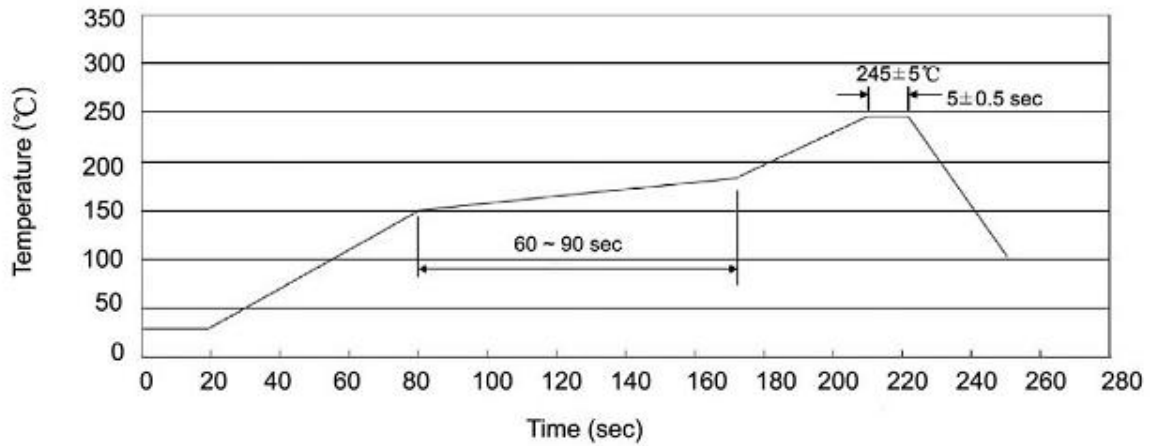

说明：

- 1、预热温度 150 ~ 180°C，时间 60 ~ 90sec;
- 2、峰值温度 245±5°C，时间持续为 5±0.5sec;
- 3、焊接制程冷却速度为 2 ~ 10°C/sec.

Note:

- 1.Preheating:150~180°C, Time:60~90sec.
- 2.Peak Temp.:245±5°C, Duration:5±0.5sec.
3. Cooling Speed: 2~10°C/sec.

耐焊接热试验条件 / Resistance to Soldering Heat Test Conditions

温度：260±5°C

时间：10±1 sec.

Temp.:260±5°C

Time:10±1 sec

包装规格 / Packaging SPEC.

卷盘包装 / REEL

Package Type 封装形式	Units 包装数量					Dimension 包装尺寸 (unit: mm ³)		
	Units/Reel 只/卷盘	Reels/Inner Box 卷盘/盒	Units/Inner Box 只/盒	Inner Boxes/Outer Box 盒/箱	Units/Outer Box 只/箱	Reel	Inner Box 盒	Outer Box 箱
SMAF	3000	5	15000	5	75000	7" ×11	185X180X105	390X385X205

使用说明 / Notices